

CE



INDUSTRIAL GROUP

**USE AND MAINTENANCE MANUAL FOR
DIAPHRAGM ACTUATED MOTOR DRIVEN DOSING PUMPS
SERIES
MSA – MSB – MSC**



SUMMARY

INTRODUCTION	3
RESPONSABILITY LIMITATIONS	3
VALIDITY	3
ENVIRONMENT AND SAFETY REQUESTS	5
ICONS AND SUGGESTIONS IN THE FOLLOWING INSTRUCTIONS	5
POTENTIALLY EXPLOSIVE AREA USE	5
SAFETY VALVE	5
SUITABILITY AND CHEMICAL COMPATIBILITY CHECK	5
ELECTROMAGNETIC COMPATIBILITY NOTE:	5
NOISE LEVELS	6
VIBRATIONS	6
HOT SURFACE	6
TRANSPORT, MOVEMENT AND STORAGE	6
RECEIVEMENT CHECK.....	6
STORAGE	6
TRANSPORTATION AND RAISING	7
STANDARD PACKAGE	7
DESCRIPTION	7
DATA STICKER	7
LIQUID END MATERIALS	8
FUNCTION PRINCIPLES	8
USE RESTRICTIONS	9
PREDICTED USE	9
RATIONALLY PREDICTED WRONG USE	9
FORBIDDEN USE.....	10
FLOWRATE ADJUSTMENT SYSTEM.....	10
MANUAL ADJUSTMENT WITH KNOB AND LINEAR VERNIER.....	10
TECHNICAL DATA	10
INSTALLATION	11
GENERAL INDICATIONS:	12
CONNECTION TO PLANT PIPES	12
ELECTRIC MOTOR CONNECTION	12
HYDRAULIC PART INSTALLATION	13
SUCTION PIPE.....	14
PROTECTION BY IMPURITIES:.....	16
LIQUIDS WHIT GAS EMISSIONS:.....	16
CALIBRATION POT	16
DISCHARGE PIPE	16
SAFETY VALVE	17
PULSATION DAMPENER.....	18
MANOMETER.....	18
START 18	
PRELIMINARY CHECKS	18
STARTING SEQUENCE	18
MAINTENANCE PROGRAM.....	18
PERIODICAL VISUAL CHECK	19
PRECAUTIONS BEFORE MAINTENANCE	19
VALVE GROUP REPLACEMENT	19
DIAPHRAGM REPLACEMENT	20
PUSHING ROD SEAL REPLACEMENT	20
GEARBOX OIL CHECK AND REPLACEMENT	21
MALFUNCTIONS AND possible SOLUTIONS	21
DECOMMISSIONING, Disposal and demolition	22
DECOMMISSIONING	22
DISPOSAL AND DEMOLITION.....	22
WARRANTY	24
REPAIRS TO AQUA ASSISTANCE CENTER.....	24

INTRODUCTION

Thanks for choosing an AQUA product. A careful reading of this manual and its compliance is recommended to preserve product and its safety requests for a long period.

This machine must be installed and used by qualified personnel, aware of national and plant safety regulations in the installation country.

Noncompliance of the following instruction will void any applicable guarantee. **Warranty terms must be moreover completed by local legislative and technical rules, in force in the country where the product will be installed.** Following instructions does not replace any plant regulation or further additive limitations, even not legislative released as safety instruction.

For a correct manage and maintenance please follow scrupulously the recommendations in this manual.

It is mandatory that technician and maintenance personnel read and understand the instructions in this manual.

The instruction Manual should be stored in a safe and dry place, easy to find and available for further questions consultation in case of needs.

In order to allow easy recognition of important indications, it is recommended to maintain this manual in good conditions (eventually replacing it) , as like the following alerts present directly on the machine:

- Machine data sticker
- Arrow indicating motor rotation direction
- Maintenance and service stickers

RESPONSABILITY LIMITATIONS

Missed observance of rules present in this manual will release AQUA from any responsibility. For any further question, not explicitly included in this manual, please contact AQUA technical support.

Dismantling, alterations or general tampering attempts will invalidate the guarantee and will release AQUA by any further responsibility for persons or object damage.

Furthermore, AQUA will not responsible in the following cases:

- Wrong installation;
- Improper machine use;
- Missing observance of installation country rules;
- Missing or incorrect maintenance;
- Non original spare parts or spare parts not specified for the requested machine
- Due to force majeure damages.

VALIDITY

This manual is valid for the following AQUA machines.

Series: MSA – MSB – MSC

Type: 4,9,14,5 ,19,22,7,18,26,34,39,11,27,41,49,54,14,30,40,65,35,75,105,150,50,110,170,250,140,300,430,670,200,450,700,1000.



FILTRATION - DOSING - DETERGENT & HYGIENE - POOL EQUIPMENT



DECLARATION OF CONFORMITY

Company:	AQUA S.p.A.
Address:	Via T. Crotti, 1 - 42018 - San Martino in Rio (RE) - ITA

Hereby declares that the products named:

- **MOTOR PUMP MSA**
- **MOTOR PUMP MSB**
- **MOTOR PUMP MSC**
- **MOTOR PUMP PSD**

Responds to the principal features of the following European Directives:

- o **2006/42 CE - Machine Directive**
- o **2011/65/UE of 08/06/2011 with subsequent update 2015/863 of 31/03/2015 - ROHS III Directives**
- o **2012/19/UE of 04/07/2012 - WEEE Directives for electrical and electronic waste**

This declaration is issued under the responsibility of Aqua S.p.A.

San Martino in Rio (RE) - 02 april 2021

Davide Vezzani
Certification Manager - Aqua S.p.A.

AQUA S.p.A.

Società soggetta a direzione e coordinamento di Finanza Cooperativa S.c.p.a.s. - Cap. Soc. € 10.052.498,00 - Sedescribe e Versato
S. Martino in Rio - 42018 - Reggio Emilia - ITALY - Sede legale: Via Crotti, 1 - Sede operativa: Via Pensata, 3 - Cod. Fisc. e P.IVA 02025440350 - Reg. Imprese di RE 02025440350
Ph. +39 0522.665805 - Fax +39 0522.646160 - www.aqua.it - email: aqua@aqua.it



ENVIRONMENT AND SAFETY REQUESTS

ICONS AND SUGGESTIONS IN THE FOLLOWING INSTRUCTIONS

Metering pumps are machines composed by dangerous parts, so:

- Improper use or tampering,
 - Safety devices removal or disconnection,
 - Missing or infrequent maintenance
- Can provide critical damage to object and personnel

In particular, the staff must be informed about danger deriving from:

 **Malfunction and/or damages to device or personnel.**

 **Explosions.**

 **Parts in tension**

 **Rotating or moving parts**

 **Corrosive or pressurized pumped**

 **Hot surface**



POTENTIALLY EXPLOSIVE AREA USE

PDM metering pumps in STANDARD version ARE NOT adequate for potentially explosive areas!

 **ATTENTION:** classified area version must be ordered for this kind of use! In ATEX area require **ONLY** machines in ATEX execution with flameproof motor . Such machines are suitable for Group II category 3, in 2/22 Zone purpose (no risks during normal use)

 **ATTENTION:** In any case PDM metering pumps ARE NOT suitable for use in zone 0/20 or 1/21 !

SAFETY VALVE

  **ATTENTION:** Diaphragm metering pumps are volumetric pumps that **MUST HAVE** an external safety valve installed on the discharge pipe to protect against overpressures. Working pressure can't in any case be above the max admissible pressure indicated on the pump sticker, even during safety valve discharge.

SUITABILITY AND CHEMICAL COMPATIBILITY CHECK

PDM pumps are suitable to LIQUID chemical dosing ONLY. All pumps are supplied in agreement to order request.

 **PLEASE NOTE:** any different use that agreed with AQUA during the order is not applicable and will cause warranty dissolution.

ELECTROMAGNETIC COMPATIBILITY NOTE:

If correctly installed **and directly connected to the power supply**, PDM metering pumps respect the limit indicated by electromagnetic rules (EMC – generic rules for industrial facilities).

 **Pumps with inverter connection or other electrical components have to be ordered for this use. Customer have to take care about checks and expedients to comply to those limits.**

NOISE LEVELS

Noise levels tested in agreement to European rule 2006/42/CE are reported here below. Used test procedure is the same as described by UNI EN ISO 3744:2010 rule.

Table value is referred to pumps used within the limits of use and installed accordingly with the instructions contained in the present operating manual.

METALLIC / PLASTIC LIQUID END MATERIAL	
Pump model	Noise pressure level
PDM 250	< 70 dB(A)
PDM 1000	< 75 dB(A)

Employer will have to take care about technical and safety measures needed to reduce risks derived by daily exposition to noises into work environment and whatever required to guarantee and preserve personnel's health.

VIBRATIONS

PDM metering pump series are not "human direct contact machines". Vibrations created are not substantial if installed respecting this manual. They result anyway under $2,5 \text{ m/s}^2$ and are not able to create dangerous situations. In case of significant vibration, stop the machine immediately and contact maintenance service.

HOT SURFACE



Some surfaces may become hot during normal use, especially near the motor and its connection flange to the pump.

Please check that the motor can be enough ventilated and that nearby objects or sunrays will not irradiate it with additional heat.

TRANSPORT, MOVEMENT AND STORAGE

RECEIVEMENT CHECK

AQUA metering pumps are supplied packaged with materials, which protect them against accidental damages during transportation.

In any case, during the reception of the package, Customer should have to verify package integrity.

Eventual damages must be notified to the transporter, and added to the Transport Document Notes.



In case of damages, before starting the machine, please contact AQUA technical assistance.

STORAGE



AQUA recommends to store the machines in their original package.

In any case if not immediately used, pumps have to be stored with adequate protections in warm and dry environment, clean, without vibrations into and protected against bad weather. Furthermore, be sure to protect from ground humidity by using a raised plan (e.g.: shelf/pallet). Avoid ambient temperature below $- 20^{\circ}\text{C}$. If the machine will not be used for a long period, AQUA recommends to load the oil to preserve internal components by oxidation. Do not stack packages (except when explicitly allowed) in order to avoid damages to the below machine or package tilting and fall, which may cause injuries. Be sure that the shelf is able to support package weight. Before starting the machine, keep it in warm environment for few hours, in order to stabilize its temperature to the working conditions.



If required, please notify in advance about special storage conditions, in order to prepare an adequate package.

TRANSPORTATION AND RAISING



During transportation, pumps have to be adequately secured and packaged to protect the contents against accidental hits, falls, or exposition to humidity. A particular attention is recommended to the pump connection.

Before than transport, oil must be drainer. Every AQUA pump is supplied with a 250 cc plastic bottle. However, after the first opening, the cap must be sealed with adhesive tape for a perfect lightening.

Standard version (manual adjustment) of PDM metering pumps does not weight above 15kg, therefore can be moved by hand. In case of special executions, please use an adequate device (trans pallets, forklift, tackle etcetera) according of packages dimension and weight.



ATTENTION: NEVER grab the pumps from their connections! This can damage the pump irreparably and cause leaks and malfunctions!

STANDARD PACKAGE



Each AQUA pump is packed into a carton box with an appropriate protection guaranteed by a foam system, which completely envelop the machine during its transport and movement.

DESCRIPTION

PDM metering pumps are composed of:

- A single-phase or tree-phase alternative current electric motor;
- A reduction gearbox which determinate pump stroke/min;
- A liquid end chemically compatible with the pumped fluid;
- A stroke adjustment knob, from 0 to 100% to requested flow rate.

DATA STICKER

Each pump comes with a sticker fixed on the pump body, like the one shown in the below picture:

<p>1 = Pump code</p> <p>2 = Max guaranteed flow rate (l/h)</p> <p>3 = Max working pressure (Bar)</p> <p>4 = Pump serial number.</p> <p>5= Made in – CE marking</p>	1 = Pump code
	2 = Max guaranteed flow rate (l/h)
	3 = Max working pressure (Bar)
	4 = Pump serial number.
	5= Made in – CE marking



ATTENTION: Keep the data sticker in good reading condition, protecting carefully.

- **Mentioned data are mandatory in case of spare parts request, maintenance informations or technical assistance.**
- **Never remove the sticker by its original position .**
- **Never edit or falsify the data mentioned in the sticker.**

Liquid end materials are indicated as per the below chart, in case of special executions.

ООО «ТИ-СИСТЕМС» ИНЖИНИРИНГ И ПОСТАВКА ТЕХНОЛОГИЧЕСКОГО ОБОРУДОВАНИЯ

Интернет: www.tisys.ru www.tisys.kz www.tisys.by www.tesec.ru www.ти-системс.рф

Телефоны: +7 (495) 7774788, 7489626, (925) 5007155, 54, 65

Эл. почта: info@tisys.ru info@tisys.kz info@tisys.by

LIQUID END MATERIALS

Wetted parts, such as Pump-head, Ball valve, Valve seats, Valves OR and Valve cage, may be made of different materials (as per the below chart), according to the chemical compatibility toward the dosed chemical:

PUMP-HEAD		BALL VALVE	VALVE SEAT	VALVES OR	VALVE CAGE
BB	PP	PYREX	PVC	FPM	PP
B0	PP	PYREX	PVC	EPDM	PP
B1	PP	CERAMIC	PVC	FPM	PP
B2	PP	PTFE	PVC	FPM	PP
B3	PP	SS316L	SS316L	FPM	PP
B4	PP	CERAMIC	PVC	EPDM	PP
B5	PP	PTFE	PVC	EPDM	PP
B6	PP	SS316L	SS316L	EPDM	PP
B7	PP	SS316L	SS316L	SILICON	PP
B9	PP	HASTELLOY	INCOLOY	EPDM	PP
FF	PVDF	PTFE	PVDF	PTFE	PVDF
F1	PVDF	CERAMIC	PVDF	PTFE	PVDF
F5	PVDF	HASTELLOY	PVDF	PTFE	PVDF
AA	SS316L	SS316L	SS316L	FPM	PP
A0	SS316L	SS316L	SS316L	EPDM	PP
A1	SS316L	SS316L	SS316L	PTFE	PP
A2	SS316L	SS316L	SS316L	FPM	SS316L
A3	SS316L	SS316L	SS316L	EPDM	SS316L
A4	SS316L	SS316L	SS316L	FPM	SS316L + MOLLA
A5	SS316L	SS316L	SS316L	EPDM	SS316L + MOLLA
A7	SS316L	SS316L	SS316L	SILICON	PP

Non standard execution codification may differ from the above mentioned ones.

FUNCTION PRINCIPLES

PDM series mechanical Diaphragm metering pumps have a spring return mechanism. Their movement is generated by an electric motor through a gearbox which allow the rotation of an eccentric shaft that axially push a pushing rod connected to the diaphragm, thus generating the Discharge phase and compressing the spring at the same time. While the rotation of the eccentric continues, the spring extends, letting the rod to go back to its original position, thus generating the Suction phase. Alternative motion produced by this mechanism allows suction and discharge of the chemical trough the liquid end with a movement so similar to a syringe piston, while the resulting action of the check valves defines the flow direction. The drive distance of the pushing rod, and consequently the quantity of dosed chemical, can be modified through the adjustment located behind the pump body.

Theoretical flow rate match with pumping part inducted volume. Actual flow rate is lower cause of the volumetric efficiency of the pump, and depends by pump type and dimensions, liquid nature and viscosity and working pressure.

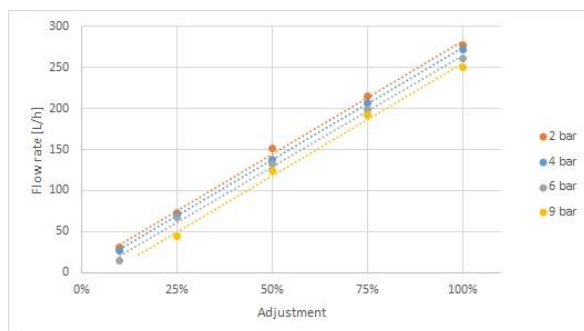

USE RESTRICTIONS

Admittable project temperature T_a for all pump types is comprehended between **-10 °C and +40°C**. Maximum temperature of pumped fluid depends by the liquid end material (as well as the fluid own characteristics)



NOTE: Periodically check the respect of temperatures limits!

Motor power mentioned in the motor plate refers to operation at altitude below 1000m a.s.l. and ambient temperatures between +5°C and +40°C. In case of installation above 1000m a.s.l., motor power will decrease proportionally, as shown in the below picture:

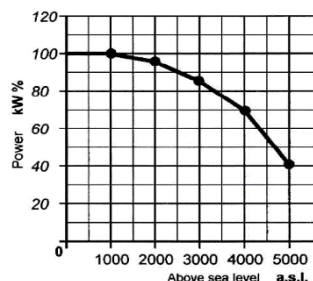

PREDICTED USE

PDM metering pumps are designated to liquid dosing (ambient temperature or heated).



Any other use must be considered "IMPROPER USE" and it is not admitted.

AQUA decline any responsibility for any eventual damage.

PDM metering pumps are suitable for a **non-continuous duty 12/24 h/day** and can be used for the following applications:

- Water and waste water treatment;
- Pharmaceutical manufacturer;
- Food industrial and agro industrial;
- Paper mills;
- Cleaning products manufacturing and dosing;
- CIP plants;
- Potabilization plants.

RATIONALLY PREDICTED WRONG USE

Following uses of PDM pumps have to be considered incorrect:

ООО «ТИ-СИСТЕМС» ИНЖИНИРИНГ И ПОСТАВКА ТЕХНОЛОГИЧЕСКОГО ОБОРУДОВАНИЯ

Интернет: www.tisys.ru www.tisys.kz www.tisys.by www.tesec.ru www.ti-sistemc.pф

Телефоны: +7 (495) 7774788, 7489626, (925) 5007155, 54, 65

Эл. почта: info@tisys.ru info@tisys.kz info@tisys.by

- Without a safety valve immediately installed after the discharge valve and in any case before than any other accessory;
- Dosing different product than specifically indicated;
- In corrosive and stagnate atmosphere enclosed in not enough ventilated area;
- Pressure dosing without manometer installed (see Discharge pipe- Manometer)
- Powered by inverter or other electric devices (if not specifically requested for this use)
- With motor faster than original (different poles)
- In potentially explosive areas (if not specifically requested for this use)

FORBIDDEN USE

It has to consider forbidden use PDM pumps in mining plants or under water.

Furthermore it is forbidden:



To use the pumps without Safety devices or with the same tampered or out of order



To Use STANDARD version pumps in ATEX areas!



To use PDM pumps in ATEX version in 0/20 – 1/21 explosive zones!

FLOWRATE ADJUSTMENT SYSTEM

PDM pumps flow rate adjustment is continuous and regular and can be modified with pump working or steady. However it's easier to adjust when the pump is working, especially for pumps with large plunger diameter.

MANUAL ADJUSTMENT WITH KNOB AND LINEAR VERNIER

Standard version of PDM metering pumps are supplied with manual micrometric adjustment. Thanks to this adjustment is possible to manage the flow rate in a very precise way with a fixed stroke progress of 1 mm each turn. This means that if the pump stroke is 4mm, you will be able to complete the entire stroke in 4 complete rounds from 0 to 100% that can be divided in parts thanks to numbers on the knob.

TECHNICAL DATA

ООО «ТИ-СИСТЕМС» ИНЖИНИРИНГ И ПОСТАВКА ТЕХНОЛОГИЧЕСКОГО ОБОРУДОВАНИЯ

Интернет: www.tisys.ru www.tisys.kz www.tisys.by www.tesec.ru www.ти-системс.рф

Телефоны: +7 (495) 7774788, 7489626, (925) 5007155, 54, 65

Эл. почта: info@tisys.ru info@tisys.kz info@tisys.by

Model		Ø Diaphragm	Ø Valve Passage	Stroke length mm	Flowrate (l/h) @ 2 bar		MAX Pressure Bar G	Strokes/Min	Motor Power KW	Threated Connections Standard	PVDF Connections	
					50 HZ	60 HZ						
FGM	4	80	5	2	5	6	12	34	0,18	1/4" BSPf	5/8" BSPm	
FGM	9				11,2	13,4	12	71				
FGM	14,5				18,2	21,8	12	106				
FGM	19				23	27,6	10	126				
FGM	22				26	NA	10	150				
FGM	7			3	9	10,8	12	34				
FGM	18				20	24	12	71				
FGM	26				31	37,2	12	106				
FGM	34				39	46,8	10	126				
FGM	39				45	NA	10	150				
FGM	11			4	13,5	16,2	12	34				
FGM	27				30	36	12	71				
FGM	41				46	55,2	12	106				
FGM	49				54,5	65,4	10	126				
FGM	54				62	NA	10	150				
FGM	14	110	8,5	2	18	22	8	34	0,18	3/8" BSPf	3/4" BSPm	
FGM	30				38	45	8	71				
FGM	40				60	72	8	106				
FGM	51				66	79	8	126				
FGM	65				80	NA	8	150				
FGM	35			4	42	50	8	34				
FGM	75				87	105	8	71				
FGM	105				120	144	8	106				
FGM	133				154	184	8	126				
FGM	150				170	NA	8	150				
FGM	50			6	65	78	8	34				
FGM	110				126	152	8	71				
FGM	170				200	240	8	106				
FGM	207				230	276	8	126				
FGM	250				275	NA	8	150				
FGM	140	170	17	6	170	204	5	34	0,37	1" BSPf	1-1/2" BSPm	
FGM	300				320	384	5	71				
FGM	430				490	588	5	106				
FGM	505				530	636	5	126				
FGM	670				700	/	5	150				
FGM	200			9	215	258	5	34				
FGM	450				505	606	5	71				
FGM	700				765	918	4	106				
FGM	800				845	1014	4	126				
FGM	1000				1020	NA	3	150				
FGM	700.../+			9	765	918	5	106				0,55
FGM	800.../+				845	1014	5	126				
FGM	1000.../+				1020	NA	4	150				

Max flow rate data refers to test with water, ambient temperature of 25°C, height of 250m a.s.l., suction height of 1mt with rigid suction pipes. Values are valid for operation @50Hz.

INSTALLATION

ООО «ТИ-СИСТЕМС» ИНЖИНИРИНГ И ПОСТАВКА ТЕХНОЛОГИЧЕСКОГО ОБОРУДОВАНИЯ

Интернет: www.tisys.ru www.tisys.kz www.tisys.by www.tesec.ru www.ти-системс.рф

Телефоны: +7 (495) 7774788, 7489626, (925) 5007155, 54, 65

Эл. почта: info@tisys.ru info@tisys.kz info@tisys.by

GENERAL INDICATIONS:

For proper pump operation, it is very important that the valve axis will be perfectly vertical.



Be sure to protect the pump from plant pipes leakages and corrosion. The pump is able to keep and handle the chemical in the pump-head only! Avoid to install pipings or accessories directly above the pump. Avoid to install the pump in corrosive or stagnant atmosphere, because the chemical fog may irreparably damage the pump!



In case of outside installation please consider an adequate protection by direct weather action (rain, sun, wind, dust and humidity) which could significantly reduce machine life. Consider moreover to use a roofing and/or sliding panels that will prominently improve pump's efficiency and safety during its whole working life.

Consider sufficient space all around the pump, in order to allow machine inspection and maintenance

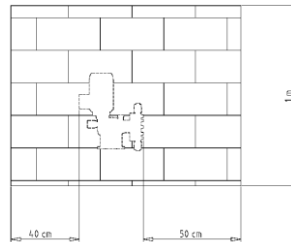

CONNECTION TO PLANT PIPES

Do not install the pump directly to cement base. Use a metallic base and ensure that it result stable and levelled to avoid further vibrations.



Pipes must be supported independently, their weight must not lie on the pump in any way, because that will create tensions on the pump, ruptures and product leaking. Do not tighten too much the piping connection to the pump-head ones, above all in case of pump-head in plastic materials, in order to avoid ruptures or deformations. To make the dismantling easier, draining connections must be installed in the discharge piping, near the liquid end.



An internal plant washing is required before connecting the pump to the pipings, with special attention to suction pipe and relevant supply tank. This procedure will eliminate any solid residues which, if lead into the pump-head, can irreparably damage the pump.

ELECTRIC MOTOR CONNECTION



For ATEX executions refer only to ATEX specific manuals in attachment to the supply!!!

Electric motor usually supplied with PDM pumps is a three-phase motor, at 230-400V tension. Depending by the version, its power can be 0,18 or 0,37 kW at 50/60 Hz. Before connecting it to the power supply, Customer must check that the plant tension complies to the motor plate, to avoid damages on electric parts. It is also recommended:

- To install always in agreement with the last safety norms;
- To install all necessary motor protection devices (for example a thermal protected switch) **NOTE: Fuses are not intended a sufficient motor protection!**
- To guarantee a sufficient space to allow motor cooling, by leaving at least 30 cm from walls and other objects.
- Not to install standard motors into extreme hot environments (ambient temperature >40°C) or at altitudes above 1000m a.s.l. In this cases an over dimensioned motor is required to balance the loss of performance caused by working environment.
- To check cable gland dimensions and tightening. They have to be adequate to entering cables dimensions in order to preserve the electric motor box by external agents and guarantee the protection.
- To check motor rotation direction during first start. It should turn in COUNTER CLOCKWISE direction if observed by the top (fan side).





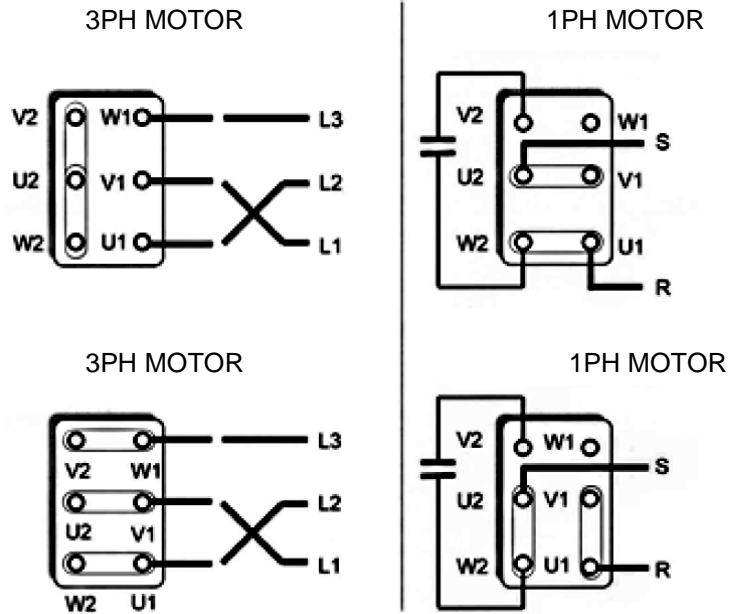



ATTENTION: Wrong cable glands or an insufficient tightening may damage the terminal box, the electric cables and jeopardize motor protection. In any case, ALWAYS connect the ground wire inside the motor box!

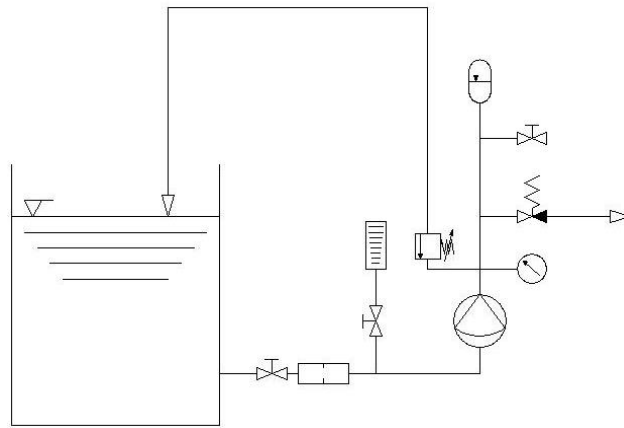





HYDRAULIC PART INSTALLATION

Customer must respect local regulation of the Country where the machine will be installed, independently from what mentioned in this manual. Here below you can find a general installation scheme:



	Metering Pump		Safety valve
	Pulsation Dampener		Calibration pot
	Manometer		Foot filter valve

	Filling system		Counter pressure valve
	Filter		Interception valve

SUCTION PIPE

- Pipe length should be reduced at minimum and be as linear as possible, using, where necessary, high range turns. In any case the maximum total length of all suction sectors should not exceed 2,5 metres;
- Never exceed 1,5 m of suction height in case of overhead installations;
- Presence of air bubbles on suction pipe compromises the pump priming. Avoid syphon turns and fluid interruptions. Take special attention to perfect seals tightening;
- Maximum liquid velocity can't exceed 0,7 m/s for viscosity until 100cPs.
- Inner diameter of suction pipe must be chosen considering pump flow meter, according to the below chart::

Maximum pump flow rate l/h	Nominal recommended Ø
$Q_{max} < 15$	Ø 6 mm
$15 \text{ l/h} < Q_{max} < 30$	Ø 10 mm
$30 \text{ l/h} < Q_{max} < 125$	Ø 16 mm
$125 \text{ l/h} < Q_{max} < 155$	Ø 20 mm
$155 \text{ l/h} < Q_{max} < 260$	Ø 25 mm
$260 \text{ l/h} < Q_{max} < 500$	Ø 32 mm
$Q_{max} > 500$	Ø 40 mm

Note: In case of viscous liquid, keep as minimum suction pipe diameter the same of the pump connections.

For an optimal suction line installation, consider the indications show in the below drawings:

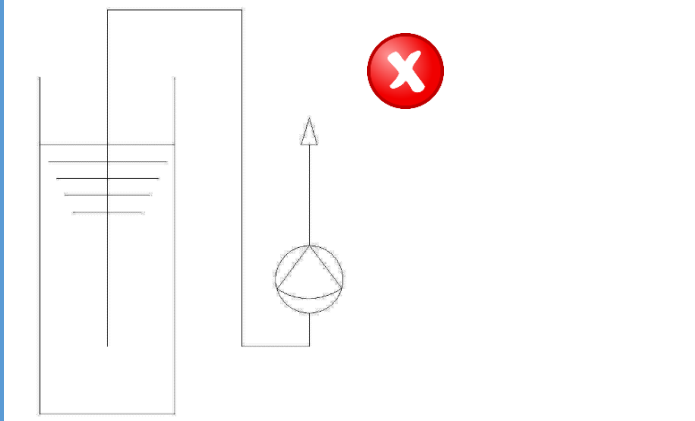
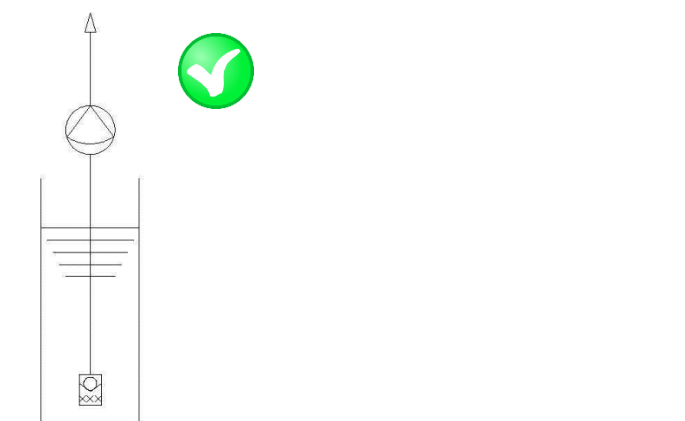
WRONG	CORRECT
 <p>FLUID GETS INTERRUPTED IN THE UPPER PART OF PIPING</p>	

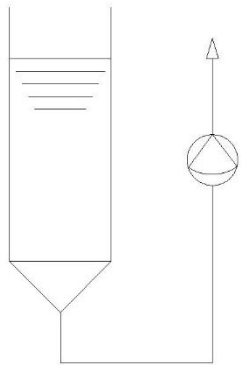

SEDIMENTS MAY ENTER IN THE PUMP HEAD AND GET STUCK INTO THE VALVES, COMPROMISING VALVE TIGHTENING.

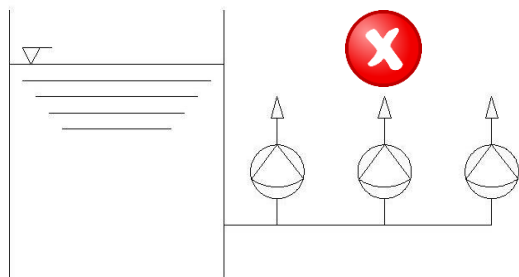
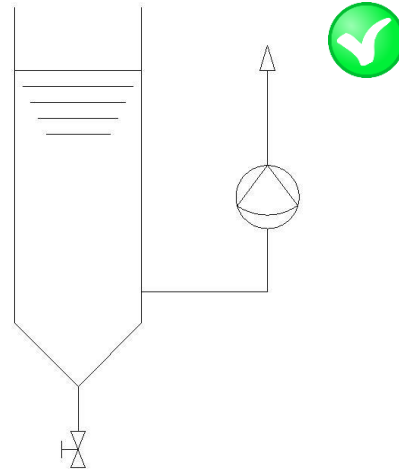

IN CASE OF MULTIPLE PUMPS, SUCTION PIPE MUST BE OVER DIMENSIONED. ALSO INSTALL A VALVE THAT ALLOWS TO DRAIN THE PLANT WHEN NEEDED.

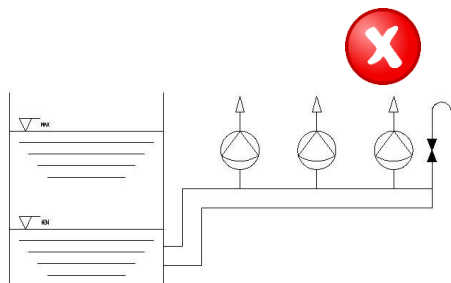
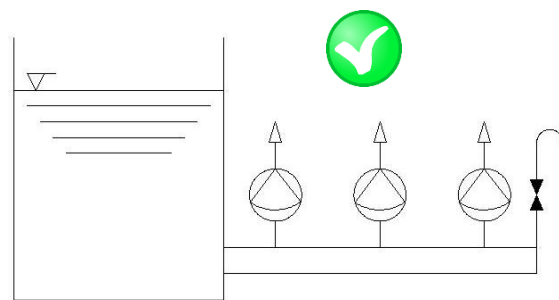

PUMPS UN-PRIME BEFORE REACHING THE TANK MINIMUM LEVEL.

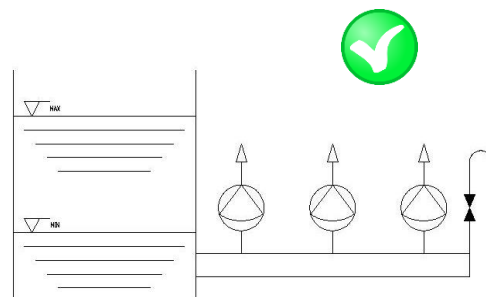

INSTALL AND KEEP SUCTION PIPE UNDER THE TANK MINIMUM LEVEL.

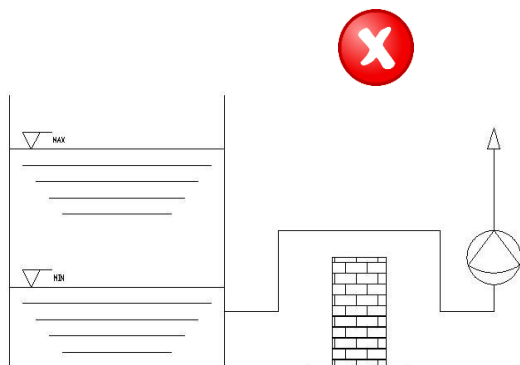

PUMPS UN-PRIME BEFORE REACHING THE TANK MINIMUM LEVEL TO AVOID AN OSTACLE

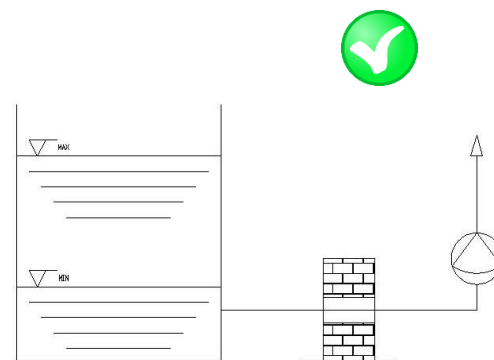

PUMP SUCTION MUST BE CONSIDERED A PRIORITY

PROTECTION BY IMPURITIES:

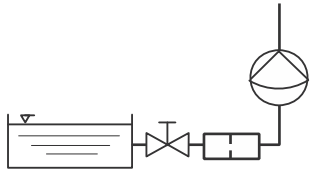

IMPORTANT

The pump may be able to transfer suspended solid parts (not soluble), but this feature must be considered a disturb for the plant because they could create cloggings and damages.

In order to reduce this issue or further damages created by solid parts into the pipes, pump-head and valves, we recommend keeping the suction pipe at 10cm from the bottom of the tank and (excluded exceptional cases indicated in following) use an adequate tool to filter.

Filter mesh must be according to the dosed fluid.

LIQUIDS WITH GAS EMISSIONS:

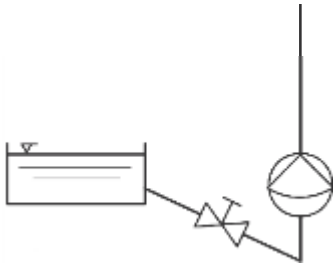

IMPORTANT

Products with large gas emission, may cause corrosion and maintenance accessibility issues, in case of vertical suction pipe directly above the tank. A side draw is recommended, ensuring to keep a soft slope to allow further gas escape toward tank side.

CALIBRATION POT

Installed on suction pipe, derivate between tank and pump, allows the calibration of actual pump flow rate in service during the normal use.

DISCHARGE PIPE

- Piping route must be as linear as possible and independently supported to avoid that weight or thermal expansions would cause deformation or excessive stress on the pump.
- It is recommended to install some "T" connections to allow easy installation of eventual accessories such as manometers, valves or pulsation dampeners.
- In case the pump is installed below the chemical level drawing, consider to install a counter pressure valve to avoid syphoning.
- Discharge pressure must be at least 0,5 bar more than suction pressure.
- For a correct discharge pipe installation, consider the suggestions shown in the below drawings:

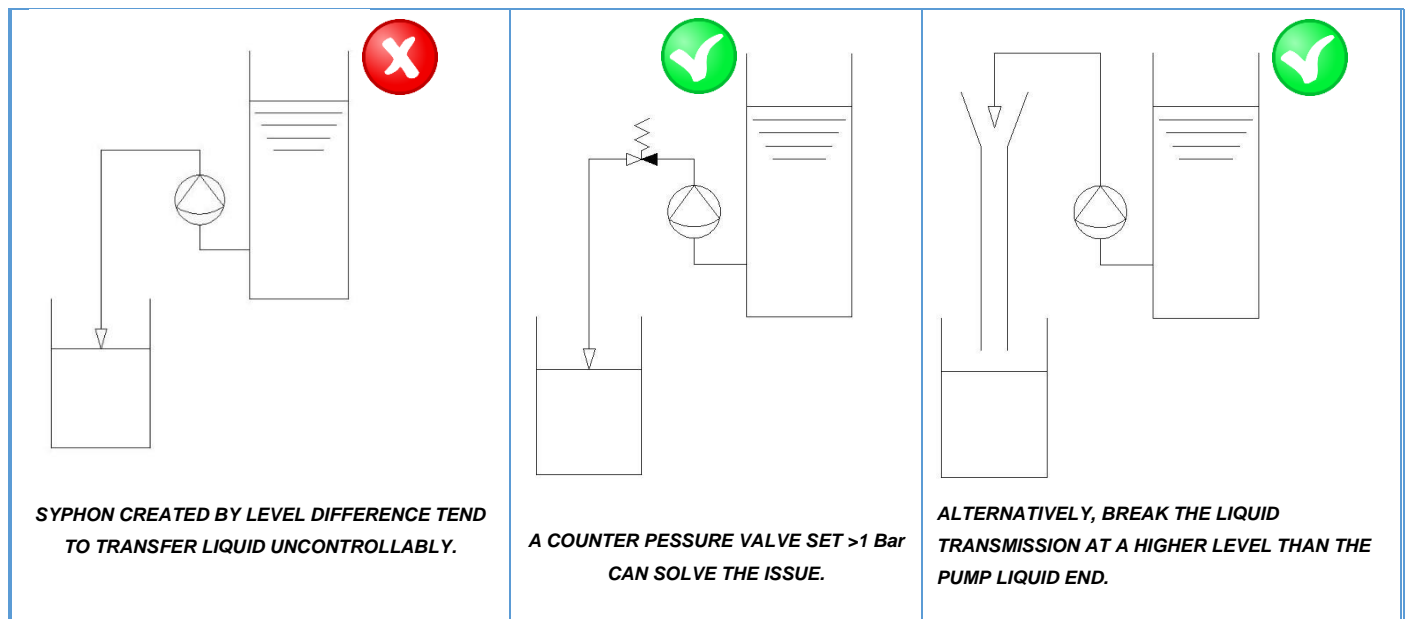

ООО «ТИ-СИСТЕМС» ИНЖИНИРИНГ И ПОСТАВКА ТЕХНОЛОГИЧЕСКОГО ОБОРУДОВАНИЯ

Интернет: www.tisys.ru www.tisys.kz www.tisys.by www.tesec.ru www.ti-sistems.pф

Телефоны: +7 (495) 7774788, 7489626, (925) 5007155, 54, 65

Эл. почта: info@tisys.ru info@tisys.kz info@tisys.by

SAFETY VALVE

PDM pumps are volumetric machines without any internal safety valve. For this reason is necessary to consider an external safety valve installed on discharge pipe near the pump and before than any other accessory to protect against any eventual pressure excess.



Missing installation of the safety valve can cause heavy damages to pump and plant! Working pressure cannot exceed the maximum reported on the pump data sticker, even during the safety valve discharge.

Safety valve discharge should be able to be monitored and conveyed in a tank to allow an immediate leaking alert.

Even in case of free discharge, a safety valve installation is recommended to avoid high pressure excesses caused by:

- Freezing obstruction or pumped chemical solidification
- Viscosity variations of the fluid (e.g. due to temperature variations)
- Accidentally flexible piping crushing
- Any other unpredictable risk which may create quick and uncontrollable pressure raising. For a correct installation, consider the suggestions shown in the below drawings:

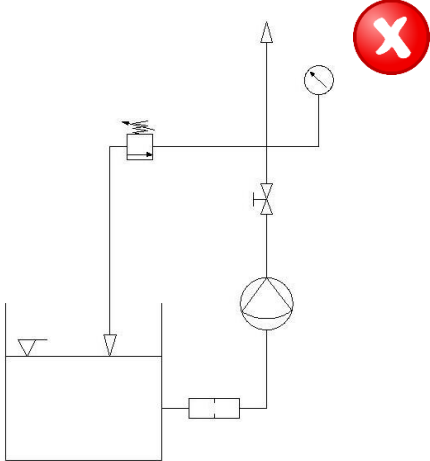
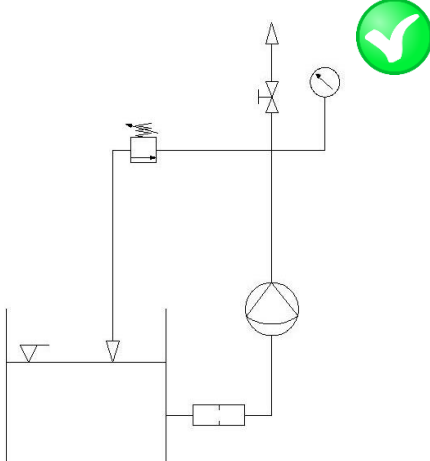
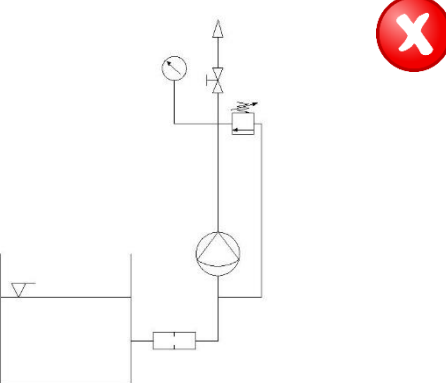
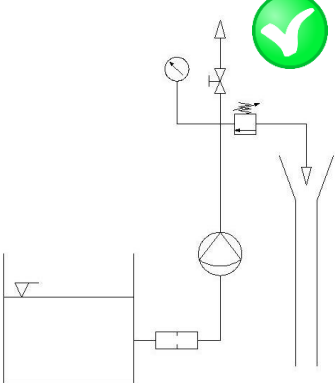
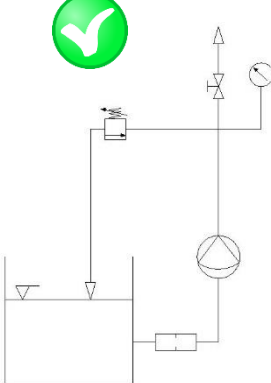
WRONG	CORRECT	
	 <p data-bbox="730 1361 1385 1384">INTERCEPTION VALVE MUST BE ALWAYS AFTER THE SAFETY VALVE!</p>	
		
<p data-bbox="124 1935 593 1989">SAFETY VALVE REFLUX ON SUCTION PIPE COULD AFFECT PUMP EFFICIENCY</p>	<p data-bbox="638 1935 1481 1989">CONNECT THE SAFETY VALVE DISCHARGE INTO THE DRAFT TANK OR INTO A DEDICATED PIPE WHICH ALLOWS TO SEE ITS DISCHARGE, THEREFORE THE MALFUNCTION</p>	

PULSATION DAMPENER

The installation of a pulsation dampener improve the pump performance and also guarantees:

- Protection against high pressure surges (fluid hammer), improving the machine long time duration;
- Continuous flow rate with a regular flux;
- Reduction of vibrations transmitted to discharge piping;
- Pump noise reduction.



NOTE: If the process needs a continuous flow rate, it is mandatory to install the pulsation dampener.

MANOMETER

It allows to check the actual working pressure of the pump. It has to be installed on the discharge pipe, near the pump and before any eventual pressure drops which could offset the right value. Periodical check of the value shown by the manometer allows to recognize further obstruction events and prevent damages to the pumps and the plant itself. Installed manometer must be of the right scale, according to the pump in the plant (e.g. for 8 bar working pressure pump, a 0-15 bar scale manometer is suggested), in order to have an easily readable value.

START

PRELIMINARY CHECKS

- Be sure there are no product leakages from the pump connections or from the plant pipings;
- Check the proper installation of all the accessories and their correct operation;
- Check correct interception valves functionality (close/open according to their position);
- Check there is no solidified/crystallized or frozen parts into dosed product and pipes
- Be sure that the pump is adequately protected against external agents like sand, dust, corrosive substances, water, vibrations, tensions, humidity or extreme thermic excursions

STARTING SEQUENCE

1. Load the oil into the gearbox using the 250 cc container supplied with the machine, through the loading cap, like shown in the picture. However the right level matches about with the middle of the oil level plug.
2. Set the adjustment at 0% and start the motor, check the counter clockwise sense of its rotation as indicated by the arrow.
3. Gradually increase the adjustment to 50% by keeping the discharge pressure at minimum, Keep this condition for at least 5 mins, and then increase to reach the 100%.
4. Adjust the counter pressure valve to the requested working pressure.
5. Set the adjustment to process request, eventually compensate the pressure drop caused by the adjustment set at a value lower than 100%.
6. During this first step, verify the actual pump working pressure by using a manometer. Maximum value cannot exceed the pressure indicated on the pump sticker.
7. Once the pressure has been set, verify that the current absorption coefficient complies to plate limits.



ATTENTION! Pump generate the maximum pressure with adjustment set to 100%. Absorption coefficient check must be executed at maximum working pressure.

MAINTENANCE PROGRAM

AQUA suggests a maintenance program frequency according to the following table:

INTERVENTION	FREQUENCY	HOURS OF SERVICES
Periodical visual check	weekly	60
Liquid end parts washing	Before than any disassembling and in case of crystallizing fluids at any machine stop.	variable
Valves group replacement	24 months	8000
Diaphragm replacement	24 months	8000

ООО «ТИ-СИСТЕМС» ИНЖИНИРИНГ И ПОСТАВКА ТЕХНОЛОГИЧЕСКОГО ОБОРУДОВАНИЯ

Интернет: www.tisys.ru www.tisys.kz www.tisys.by www.tesec.ru www.ти-системс.рф

Телефоны: +7 (495) 7774788, 7489626, (925) 5007155, 54, 65

Эл. почта: info@tisys.ru info@tisys.kz info@tisys.by

Gearbox seals replacements	24 months	8000
Gearbox oil replacement	24 months	8000





PERIODICAL VISUAL CHECK

Verify at least weekly:

- Absence of pumped fluid / oil leaks. In case of seal or diaphragm rupture. this will be shown in the bottom of diaphragm chamber, as indicated in figure:
- Absence of abnormal noises or vibrations;
- Correct Tightening Torque and further oxidation of electric parts;
- Correct connections tightness and their seals;
- Power consumption limits respect and thermal protection set;
- Oil level matching with the middle of the oil level plug and the absence of oil leaks or contaminations;
- General machine Cleanliness and the absence of fouling in particular nearly the motor;
- Good general condition of paint, especially in corrosive environments.

PRECAUTIONS BEFORE MAINTENANCE

Before operating in any part of the pump:

-  **Stop the motor and disconnect the pump and any auxiliary connection from the electric power.**
-  **Ensure the impossibility of accidental start.**
-  **Depressurize. Close suction and discharge interception valves, then empty the liquid end and piping parts in communication with any parts of liquid.**
-  **Waiting until the pump cools down. ATTENTION: Electric motor surface temperature may exceed 50°C during normal use.**
-  **Capillary wash the liquid end in contact with the pumped product with compatible substances utilizing an adequate protection. ATTENTION! Products remains trapped in the liquid end when the machine is stopped. So for a good cleaning is necessary to dismantle the valve groups and clean the pump head separately. Alternatively the washing flux must be directed trough the suction valve with the same direction of the pumped fluid when the pump works.**

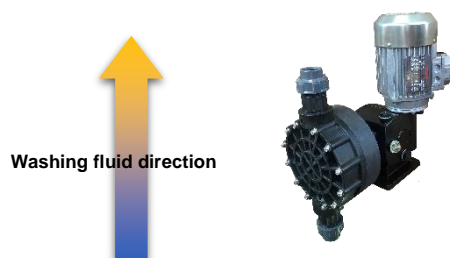

VALVE GROUP REPLACEMENT

1. Disconnect the pump by suction and delivery pipes after an adequate wash.
2. Unscrew valve groups **by hand or EAT1 device** if the liquid end is in plastic material. In case of metallic version, you can just unscrew the valve housing a wrench n. 27.
3. Replace with the new valve groups, supplied already pre-assembled by AQUA following the indication of the fluid direction, screwing using EAT1 or a n. 27 wrench tool according to the liquid end material.

Attention! In case of group inversion, the pump will not work!



ATTENTION: Do not use rib joint pliers to tighten the valve groups to the liquid end, especially for plastic liquid end version!
It is possible to recognize Suction and Delivery valve kit by looking at the following pictures:

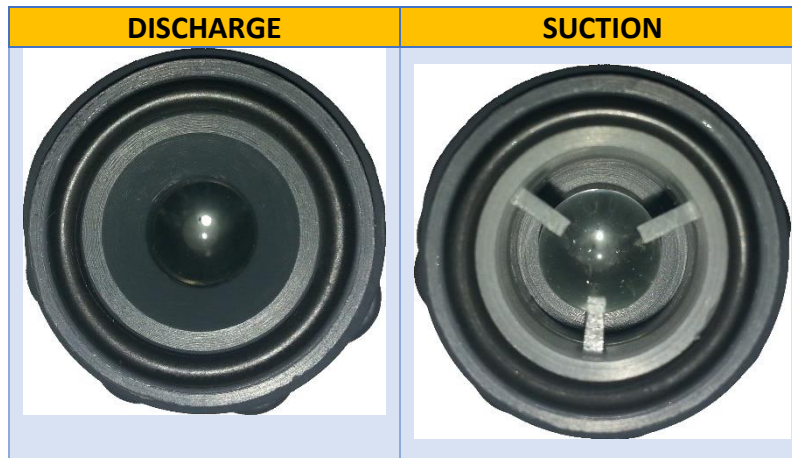

DIAPHRAGM REPLACEMENT

1. Disconnect the pump by the plant, and wash it.
2. Unscrew the valve groups
3. Unscrew liquid end screws (Pos. 509) and remove the pump head (Pos.508)
4. Unscrew the diaphragm (Pos.510)
5. Clean the internal part of the pump head (Pos.508) and diaphragm chamber (Pos.511) with special attention to diaphragm staple zone.
6. Apply some grease on pushing rod thread (Pos.127).
7. Screw the new diaphragm until the mechanical stop.
8. Mount the pump head following a star scheme screw lock to have a perfect balancement and with a torque of 5 Nm
9. Mount the valve group



PUSHING ROD SEAL REPLACEMENT

1. Follow the previous sequence until point 4.
2. Drain the oil by removing the drain plug (Pos.115) recovering it in the bottle supplied with the machine or in another adequate container.
3. Remove O-ring Pos.132
4. Set the adjustment to 0%, by turning the knob (A), to allow the advancement of the pushing rod (Pos. 127) ad in this way an easy access.
5. Remove the seal (Pos. 131) then enlarge the inner lip of the seal with a wrench and plier, insert a flat screwdriver and uncap the seal rotating the screwdriver, like shown in the picture. **Do not mount a seal once it have been removed.**
6. Place the new seal on its seat on the diaphragm chamber (511) according to the sense indicated in following picture. Lean EAT2 against the seal (131) and hit with a small rubber mallet until reaching the mechanical stop. Finally, if required, invite the lip using your finger around the pushing rod (127) being sure it correctly fits. ATTENTION! Pay special attention if using different tools, in order not to damage the seal, avoiding premature oil leakages!
7. Screw EAT3 tool on pushing rod, and push the O-ring (132) beside the conic surface reaching the inner lip of the seal (Pos. 131), then remove EAT3.
8. Follow the diaphragm replacement sequence from point 5 to the end.
9. Refill the gearbox with its oil

ООО «ТИ-СИСТЕМС» ИНЖИНИРИНГ И ПОСТАВКА ТЕХНОЛОГИЧЕСКОГО ОБОРУДОВАНИЯ

Интернет: www.tisys.ru www.tisys.kz www.tisys.by www.tesec.ru www.ти-системс.рф

Телефоны: +7 (495) 7774788, 7489626, (925) 5007155, 54, 65

Эл. почта: info@tisys.ru info@tisys.kz info@tisys.by

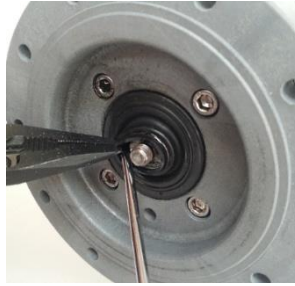

GEARBOX OIL CHECK AND REPLACEMENT.

If oil contamination appears during a periodical visual check, it is recommended to move up the oil replacement. Load, drain and level caps are shown in the picture in paragraph 6.2.



Chemically contaminated lubricants may cause abnormal wear, corrosion and leaks from seals. A complete oil replacement is much more recommended than simply top up the oil level.

Use mineral oil with ISO viscosity index VG 320 (320 cSt at a 40 °C or 23 °E at 50 °C).

MALFUNCTIONS AND POSSIBLE SOLUTIONS

Here below, a non-exhaustive list of common issues and their possible solutions.

ISSUE	PROBABLY CAUSE	FIX
Unexpected flow rate decreasing	<ul style="list-style-type: none"> Air came in the suction pipe. 	<ul style="list-style-type: none"> Check the pipe connection and tightening.
	<ul style="list-style-type: none"> Air trapped on liquid end group 	<ul style="list-style-type: none"> Increase and maintain for a short time the pump adjustment to 100% to evacuate the air
	<ul style="list-style-type: none"> Exceeding suction pipe high 	<ul style="list-style-type: none"> Decrease the length of suction pipe.
	<ul style="list-style-type: none"> Elevated vapour pressure 	<ul style="list-style-type: none"> Increase the external suction head
	<ul style="list-style-type: none"> Elevated pumping temperature level 	<ul style="list-style-type: none"> Increase the external suction head
	<ul style="list-style-type: none"> Higher liquid viscosity level 	<ul style="list-style-type: none"> Replace the suction pipe with an over dimensioned Increase the external suction head
	<ul style="list-style-type: none"> Exceeding tight closing or tank without bleed 	<ul style="list-style-type: none"> Execute a hole on the top of the tank
	<ul style="list-style-type: none"> Suction pipe obstructed or close for interception 	<ul style="list-style-type: none"> Check the suction pipe
	<ul style="list-style-type: none"> Obstructed Filter 	<ul style="list-style-type: none"> Clean or replace the filter.
	<ul style="list-style-type: none"> Pump valves are dirt, worn or assembled in wrong way. 	<ul style="list-style-type: none"> Check Cleanliness, worn and correct valves assembling.
	<ul style="list-style-type: none"> Safety valve has set with a lower pressure. 	<ul style="list-style-type: none"> Check if safety valve discharge.
<ul style="list-style-type: none"> Wrong adjustment set 	<ul style="list-style-type: none"> Check ad in case set the adjustment. 	
Product leaks	<ul style="list-style-type: none"> If appears between diaphragm chamber and pump head, tightening torque is not adequate with working pressure. 	<ul style="list-style-type: none"> Gradually tight liquid end screws until eliminate the leak or reduce the pressure.
	<ul style="list-style-type: none"> If appears from the chamber hole, it reports diaphragm rupture. 	<ul style="list-style-type: none"> Replace the diaphragm.
Irregular or higher than expected flow rate	<ul style="list-style-type: none"> Required suction pressure is higher than delivery pressure. 	<ul style="list-style-type: none"> Delivery pressure should be at least 0,3-0,5 bar higher than suction pressure.
	<ul style="list-style-type: none"> Counter pressure valve is not able to open cause of impurities or set with a too lower pressure. 	<ul style="list-style-type: none"> Check counter pressure valve conditions.
	<ul style="list-style-type: none"> Pump valves jammed in open position. 	<ul style="list-style-type: none"> Check the pump valves. Unmount and clean them accurately. Eventually replace the valve groups.

ООО «ТИ-СИСТЕМС» ИНЖИНИРИНГ И ПОСТАВКА ТЕХНОЛОГИЧЕСКОГО ОБОРУДОВАНИЯ

Интернет: www.tisys.ru www.tisys.kz www.tisys.by www.tesec.ru www.ti-sistems.pф

Телефоны: +7 (495) 7774788, 7489626, (925) 5007155, 54, 65

Эл. почта: info@tisys.ru info@tisys.kz info@tisys.by

Excessive gearbox or motor heating	<ul style="list-style-type: none"> Wrong electrical connections. 	<ul style="list-style-type: none"> Check the electrical connections and motor absorption level.
	<ul style="list-style-type: none"> Real working pressure higher than the max admitted pressure. 	<ul style="list-style-type: none"> Install a manometer on delivery pipe and check for the real delivery pressure. In case, reduce the pressure to admitted value.
	<ul style="list-style-type: none"> Delivery pipe contains section reductions that consistently increase the working pressure. 	<ul style="list-style-type: none"> Reduce the working pressure or install a pulsation dampener to stabilize it and eliminate pressure peaks.
	<ul style="list-style-type: none"> Pipes transmit vibrations to pump connections 	<ul style="list-style-type: none"> Reduce the working pressure or install a pulsation dampener to stabilize it and eliminate pressure peaks.
	<ul style="list-style-type: none"> Obstructed delivery pipe or closed by interception valve. 	<ul style="list-style-type: none"> Check the delivery valve.
	<ul style="list-style-type: none"> Counter pressure valve set as an higher than admitted pressure. 	<ul style="list-style-type: none"> Check the counter pressure valve set.
	<ul style="list-style-type: none"> Oil level too low or chemically contaminated. 	<ul style="list-style-type: none"> Check and in case replace the oil

DECOMMITIONING, DISPOSAL AND DEMOLITION

DECOMMITIONING

Before removing the pump from the plant, carefully follow the instructions at paragraph 7.3 “PRECAUTIONS BEFORE MAINTENANCE”. Pay particular attention when washing the pump wetted parts: pump-head and valve groups.

 **Capillary wash the liquid end in contact with the pumped product with compatible substances utilizing an adequate protection. ATTENTION! Product remains trapped in the liquid end when the machine is stopped. Therefore for a good cleaning it is necessary to dismantle the valve groups and clean the pump head separately. Alternatively the washing flux must be directed trough the suction valve with the same direction of the pumped fluid when the pump works.**

DISPOSAL AND DEMOLITION

Pumps are composed by some metallic and plastic parts, and has an electric motor. Gearbox contains oil and it is painted with a dust base paint It is user responsibility to respect every local procedure and regulation for a correct disposal and demolition regards all further waste created during machine maintenance, disposal or demolition. **Missing observance of this rules can provide administrative or criminal penalties.** Before demolishing a pump or dismount for a parts disposal:



- Carefully follow instructions in paragraphs 7.3 and 9.1, paying particular attention t the liquid end cleaning and connections.
- Completely drain the oil removing the drin plug and recover it into the supplied oil container or in an adequate alternative.
- Carefully clean the internal of the gearbox with appropriate products ensuring to remove all present oil traces.

 **Only if accurately cleaned, maintenance or demolition waste can be considered “special wastes”. Otherwise they have to be threatened like “dangerous wastes”**

 **It is absolutely forbidden to mix several types of wastes!!**

 **Avoid environment or sewer release of products.**

To preserve the enviroment AQUA reccomeds to separe all machine components, clean, ad leave them to specialized recycling consortiums and companies. PDM components are listed in the following chart:





POS.	MATERIAL	NORMATIVE SIMBOL/CODE	NOTE
101 (Electric motor)	Copper and other materials	RAEE 160216	Electric Motor
502, 121	Polypropylene		
126	Polyamide		Side shell
130	Polyamide/Aluminum		Pump body (for pumps with diaphragm size 80 and 110 mm, consider polyamide pump body, for 170 mm diaphragm size consider aluminum pump body)

ООО «ТИ-СИСТЕМС» ИНЖИНИРИНГ И ПОСТАВКА ТЕХНОЛОГИЧЕСКОГО ОБОРУДОВАНИЯ

Интернет: www.tisys.ru www.tisys.kz www.tisys.by www.tesec.ru www.ти-системс.рф

Телефоны: +7 (495) 7774788, 7489626, (925) 5007155, 54, 65

Эл. почта: info@tisys.ru info@tisys.kz info@tisys.by

116, 117, 118, 119, 136	Mainly Steel	n. a.	Ball bearings can be regenerated.
103, 108, 120, 122, 123, 124, 125, 127, 128, 129, 133, 134, 501*, 505**, 506*, 508**, 509, 512, 514, 515	Steel		*Only for B33 and A executions. **Only for A executions.
102	Galvanized iron	n.a.	
105, 106, 107, 109, 110, 111, 112, 113, 114, 115, 131, 132, 135, 137, 510,503,504, 513, 501^, 502^, 505^, 506, 508^, 517	Other plastic materials		^Only for F executions
104, 505, 508, 511	Glass fiber filled Polypropylene	95 C/PP	
507, 516	PVC		
Inside the gearbox	Lubrificant Oil	n.a.	Attention! Dangerous waste not biodegradable Can be regenerated if leaved to specialized authorized companies.
Carton box package	Recycled carton		

WARRANTY

AQUA base guarantee, valid for all products, cover against all **verified** deficiencies for a period of 12 (twelve) use months or 18 (eighteen) months of dispatch document. In order phase is possible to request a warranty extension of 36 and 60 months together with necessary maintenance kits (see 7.1).

In any case, warranty do not cover:

1. Wearing susceptible parts caused by use beyond the normal condition of use (see 7.1, 4.5 e 4.4)
2. AQUA personnel intervention, including travel expenses, room and board.
3. Pump transportation costs to AQUA assistance point.
4. Machine installation not complying to this manual instruction (see point 6)
5. Tampered or disassembled machines, excluded predicted maintenance (see point 7)
6. In case of extended warranty, if not adequately maintained machines, as mentioned in point . 7
7. Machines with non-original AQUA spare parts or customer custom-made parts.

 **ATTENTION! AQUA recommends to do not try any dismantling or fixing n warranty covered products, to avoid the warranty cover invalidation . Contact pre-emptively AQUA customer service to obtain informations.**

REPAIRS TO AQUA ASSISTANCE CENTER

Before sending a pump to AQUA, Customer must comply with the following procedure:

1. Contact AQUA to have information about the nearest assistance point to which send the pump, including a short description of the issue and sticker data (all fields), paying particular attention to the Serial Number and pump code.
2. Follow instruction of paragraph 7.3 “**Precautions Before Maintenance**” and 9.1 “**Dismission**” paying particular attention to wetted parts cleaning.
3. Drain the oil by removing the drain plug and recovering it into the supplied container or in another adequate container.
4. Package the machine in appropriate way to avoid ruptures during the transportation. AQUA suggest to use its original package if still available, with dismantled valve groups, which needs to be cleaned and packaged separately.
5. Include a declaration of cleaned machine, which certificate that technicians for repairs can handle this machine safely.
6. Every product must be delivered in freight.



ООО «ТИ-СИСТЕМС» ИНЖИНИРИНГ И ПОСТАВКА ТЕХНОЛОГИЧЕСКОГО ОБОРУДОВАНИЯ
Интернет: www.tisys.ru www.tisys.kz www.tisys.by www.tesec.ru www.ти-системс.рф
Телефоны: +7 (495) 7774788, 7489626, (925) 5007155, 54, 65
Эл. почта: info@tisys.ru info@tisys.kz info@tisys.by