

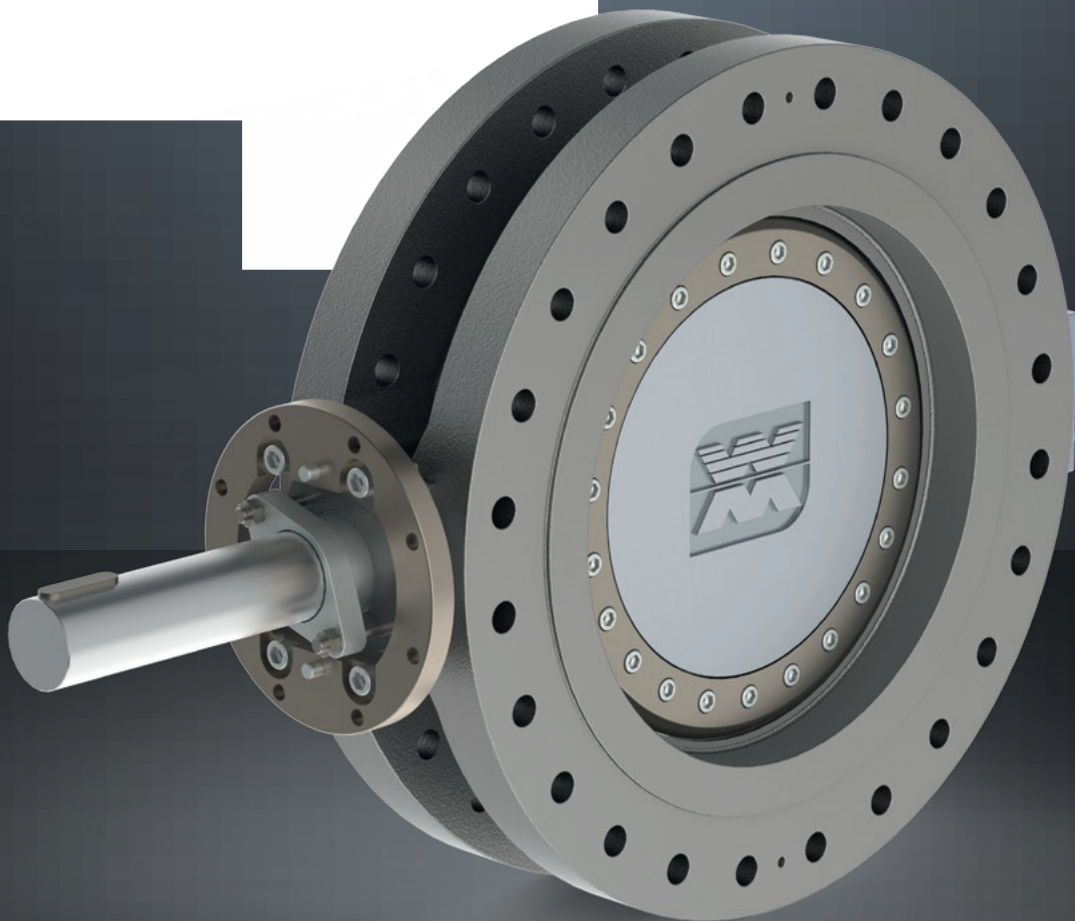

4

OFFSET BUTTERFLY VALVES



ООО «ТИ-СИСТЕМС» ИНЖИНИРИНГ И ПОСТАВКА ТЕХНОЛОГИЧЕСКОГО ОБОРУДОВАНИЯ

Интернет: www.tisys.ru www.tisys.kz www.tisys.by www.tesec.ru www.ти-системс.рф

Телефоны: +7 (495) 7774788, 7489626, (925) 5007155, 54, 65 Эл. почта: info@tisys.ru info@tisys.kz info@tisys.by

THE FANTASTIC

4

LOW MAINTENANCE
FRICTION FREE
HIGH PERFORMANCE
LONG SERVICE LIFE

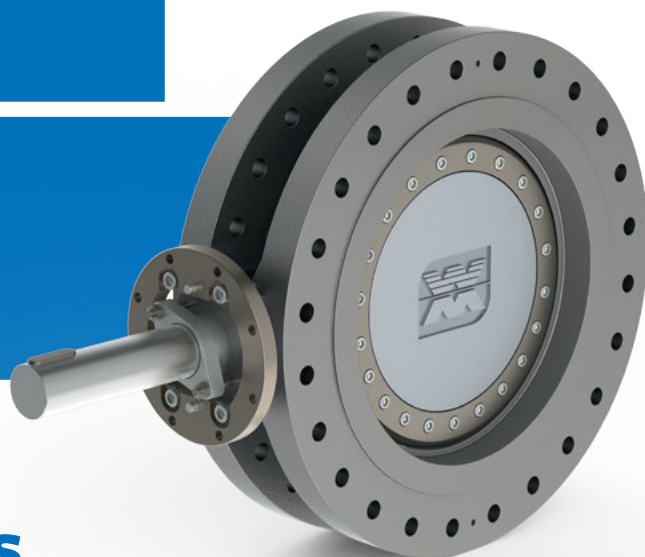

QUADAX® BUTTERFLY VALVES FOR MAXIMUM EFFICIENCY

Thanks to four offset construction and state of the art manufacturing technology, Quadax® valves offer **100% compliance even with the highest tightness requirements**. The innovative design principle means that even **extreme temperatures of -270°C to +800°C** are easy to handle.

The Quadax® butterfly valve is the optimum solution for demanding customers with the highest tightness requirements in **the most extreme applications and temperature ranges**.

We produce the Quadax® butterfly valves from the **highest quality materials** and on **modern 5-axis machining centres** at our **location in Germany**.

ООО «ТИ-СИСТЕМС» ИНЖИНИРИНГ И ПОСТАВКА ТЕХНОЛОГИЧЕСКОГО ОБОРУДОВАНИЯ

Интернет: www.tisys.ru www.tisys.kz www.tisys.by www.tesec.ru www.ти-системс.рф

Телефоны: +7 (495) 7774788, 7489626, (925) 5007155, 54, 65 Эл. почта: info@tisys.ru info@tisys.kz info@tisys.by

CENTRIC BUTTERFLY VALVE

The turning point is in the centre of the seat and in the centre of the pipe.

→ Only elastomer seals are possible.

SINGLE OFFSET BUTTERFLY VALVE

The turning point of the disc is offset along the direction of the pipe.

→ 100 % friction between seat and seal
→ Increased torque and wear

DOUBLE OFFSET BUTTERFLY VALVE

The turning point of the disc is also offset from the centre of the pipe towards the outer edge.

→ Approx. 30 % friction between seat and seal

TRIPLE OFFSET BUTTERFLY VALVE

The seat has a conical shape. The tip of the cone is offset from the centre of the pipe towards the outer edge. A circular cone results in an elliptical narrow seat in the valve body.

→ Approx. 2-5 % friction between seat and seal

FOUR OFFSET BUTTERFLY VALVE

On the four offset butterfly valve, the output cone used is elliptical. The section under a particular angle results in a circular and therefore larger sealing area.

- **Friction free**
- **Higher Kv value**
- **Highest tightness**
(even under extreme conditions)

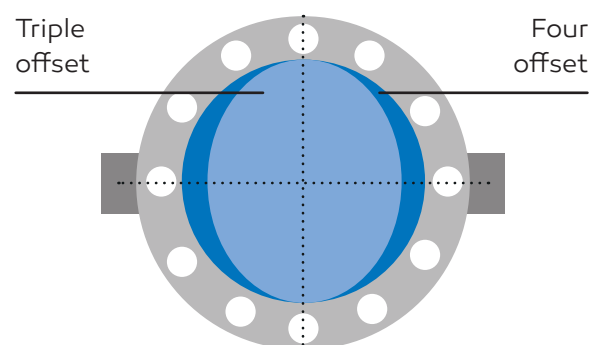
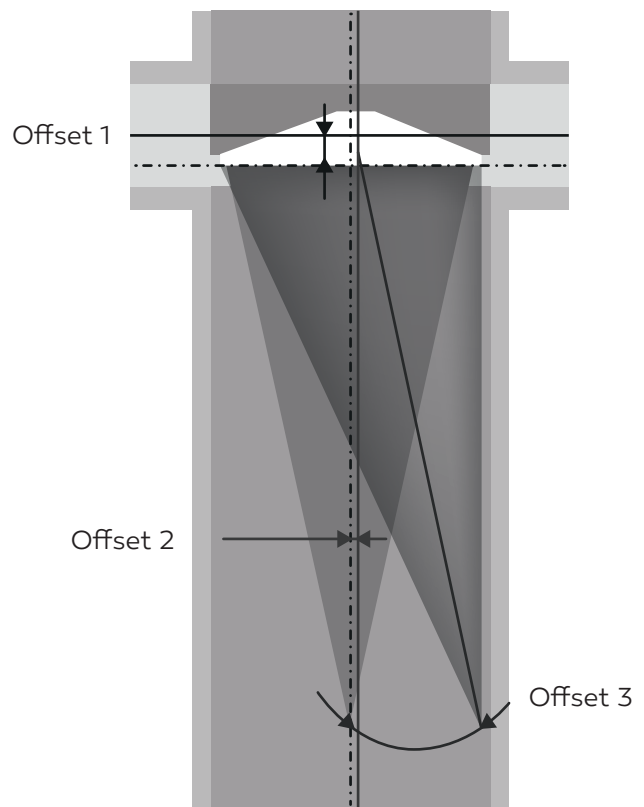

HIGHLIGHTS

Temperature range from -270°C to $+800^{\circ}\text{C}$

Tight in both directions – up to full pressure

Sealed bearings design as an option

Friction free / very low torques

New disc design, minimum shaft deflection even at very high pressures

Available up to 160 bar and above

No movement between disc and seal – absolute tightness between seal and disc





ISO top flange for actuation

Zero leakages, also in
cryogenic applications

Floating disc design

Available up to DN 1800 mm
and above

Fire safe in both directions

All metal seals possible

Dead leg area minimised due to
four offset design, higher Kv/Cv value
and less accumulation of dirt

ADVANTAGES

4 WINS

Compared to triple offset butterfly valves, the four offset Quadax® reduces your **process costs** while simultaneously increasing **process reliability**.

With Quadax® you are choosing a combination of **premium performance** and **maximum value for money**.

In contrast to the **elliptical seal geometry** of conventional triple offset butterfly valves, the Quadax® features a **totally circular seal geometry**.

EXTREME TEMPERATURE RANGES

Even wall thickness all the way around

Extreme temperatures from -270°C to +800°C

Large temperature differences are easy to handle

SUPERIOR TIGHTNESS

Highest tightness requirements

Bubble tight even in cryogenic applications

Innovative and patented sealing design



INCREASED OPERATION SAFETY

Totally friction free on seat

Reduced risk of failure

No wear on sealing area

Longer service life



REDUCED OPERATING COSTS

Higher Kv/Cv values

Lower pipe nominal diameters

Totally friction free on sealing area

Lower torques

Reduced maintenance costs



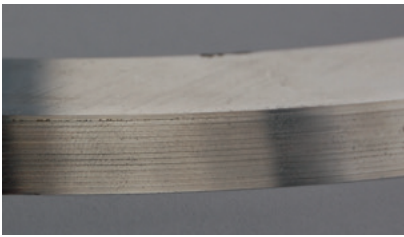

Stainless steel lamella

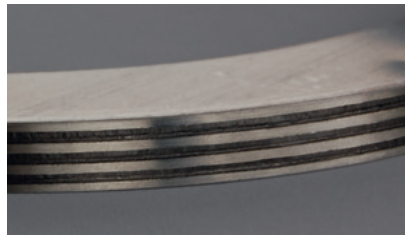

Graphite lamella

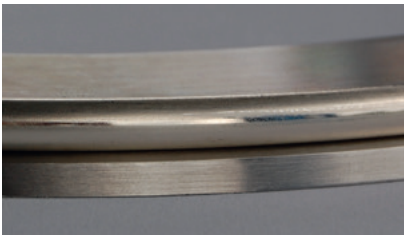

Inconel O-ring



Inconel graphite lamella

STANDARDS

2014/68 EU Pressure Equipment Directive

DIN EN 12516 (DIN 3840)

ANSI B 16.34

AD 2000

AD W 10

BAM oxygen approval

Technical Instructions on Air Quality (TA Luft II)
ISO 15848

NACE MR 0175, NACE MR 0103

2014/34/EU ATEX

Leak rate 1
in compliance with DIN 3230 BA / BO / BN test

Leak rate A
in compliance with DIN EN 12266

Tightness significantly exceeds BS 6364

Fire safe in both directions
in compliance with ISO10497, API 607, BS 6755

SIL 3



APPLICATIONS

Thanks to its unique design, four offset construction and brand new manufacturing technology, Quadax® meets the highest tightness requirements, even in extreme pressure and temperature ranges. This makes Quadax® butterfly valves ideal for use in the oil and gas industry, petrochemicals, cryogenics, refineries, LNG + LPG systems and many other applications.

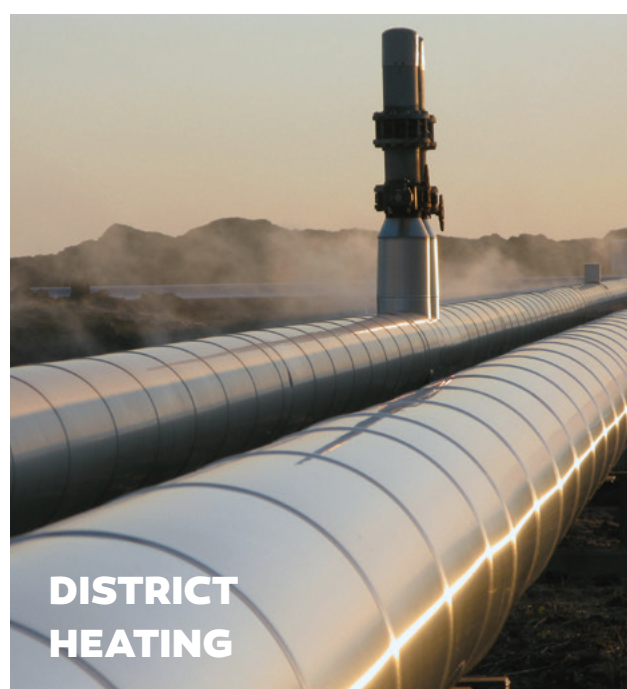
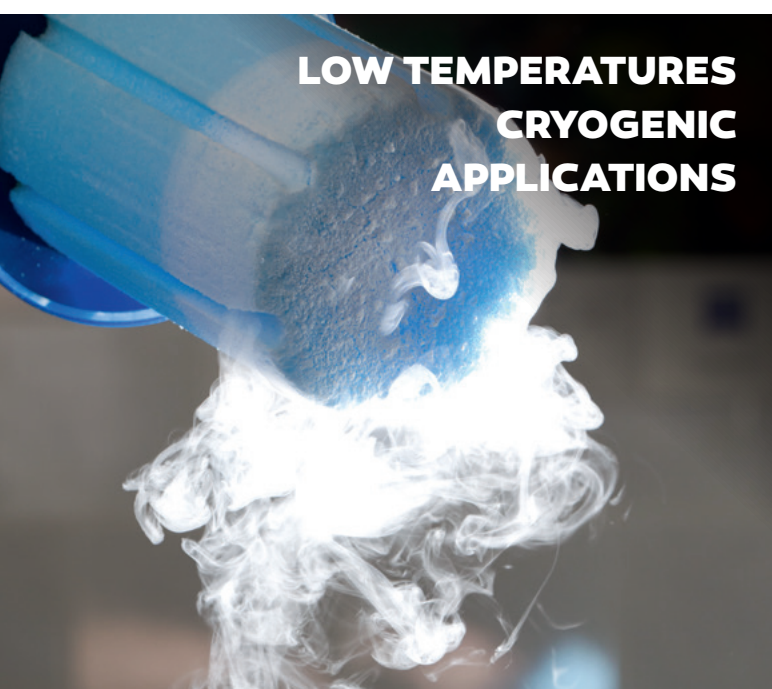
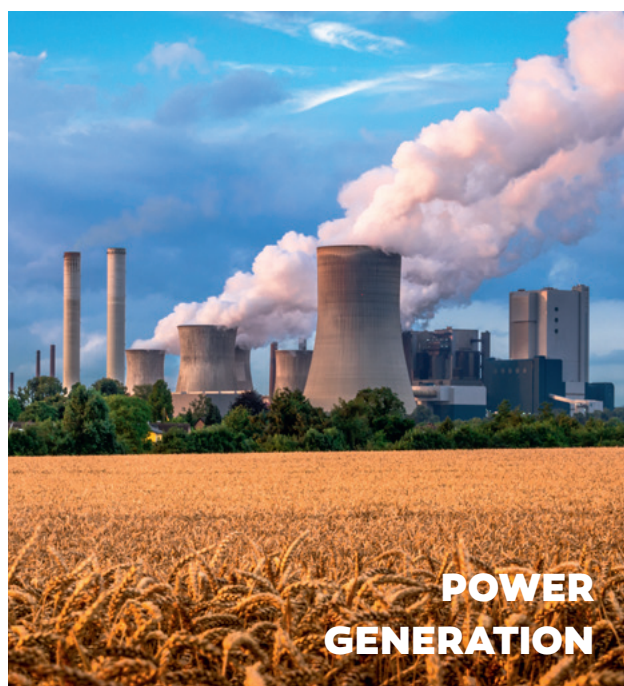
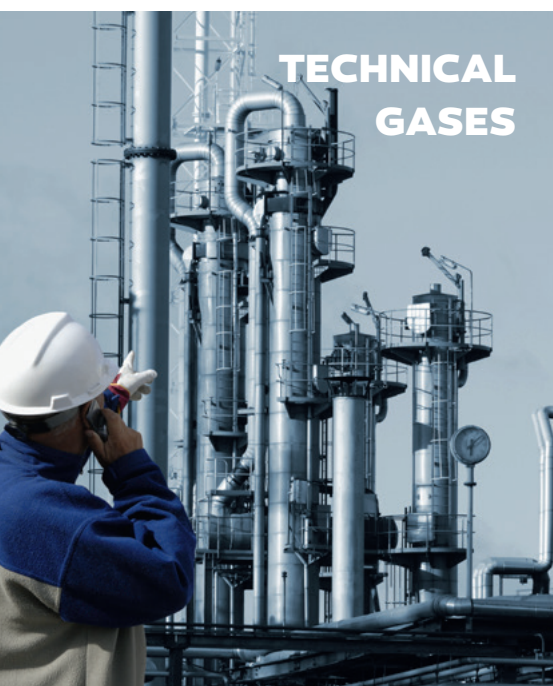

LNG + LPG

Waste gases

Steam

Technical gases

Oxygen

Chemical process media

Cryogenic media

Seawater



PULP & PAPER

**REFINERIES/PETROCHEMICALS
STORAGE TANKS**

ООО «ТИ-СИСТЕМС» ИНЖИНИРИНГ И ПОСТАВКА ТЕХНОЛОГИЧЕСКОГО ОБОРУДОВАНИЯ

Интернет: www.tisys.ru www.tisys.kz www.tisys.by www.tesec.ru www.ти-системс.рф

Телефоны: +7 (495) 7774788, 7489626, (925) 5007155, 54, 65 Эл. почта: info@tisys.ru info@tisys.kz info@tisys.by

Quadax[®] butterfly valve

DOUBLE FLANGE VERSION

PRODUCT FEATURES

This version is fitted with a flange on both sides and is connected to the pipe using a screw and nut joint. It is the shortest design after the lug type version.



SPECIFICATIONS

Nominal size	DN 50–1800, 2"–70" and above
Length	EN558 R13 / ISO 5752 F16 (PN10–40/class 150–300) EN558 R14 / ISO 5752 F4 (PN63–160/class 600–900)
Materials	Steel, stainless steel, special materials (duplex, inconel, bronze)
Function	NC, NO, DA
Pressure range	Body pressure up to 160 bar Δp standard shaft 52 bar in both directions Δp special shaft 100 bar in both directions
Leak rate	1 DIN 3230, A DIN EN 12266, BS 6364, Fire safe, API 598, ANSI FCI 70-2 Class VI
Flow direction	bi-directional with preferred direction indicated on the valve
Operating and ambient temperature	Standard -10°C to +450°C With special materials -270°C to +800°C
Approvals	PED, Fire safe, BAM, TA Luft, ATEX, SIL 3 etc.

TECHNICAL DATA

Nominal size	80	100	125	150	200	250	300	350	400	450	500	600	700	750	800	900	1000
Δp max. 20 bar							3837	5478	7944	10735	12921	20651	25473	32661	36123	47565	56131
Kv value Δp max. 52 bar	118	258	418	654	1445	2451	3720	5120	7321	9986	12118	19253	23081	30015	33343	43215	51398
Δp max. 104 bar					1254	2123	3180	4459	6282	8738	10245	16458	19826	22286	28632	38954	44444
Δp max. 155 bar	101	208	344	576	1164	1916	2926	3962	5659	7989	9442	15002	18231	21206	26779	34693	40870
Δp max. 290 psi							4462	6370	9237	12483	15024	24013	29620	37978	42003	55308	65269
Cv value Δp max. 754 psi	137	300	486	760	1680	2850	4314	5953	8513	11612	14091	22387	26838	31702	38771	50250	59765
Δp max. 1500 psi					1458	2469	3698	5185	7305	10160	11913	19137	23053	25914	33293	45295	51679
Δp max. 2250 psi	117	242	400	670	1353	2228	3402	4607	6580	9290	10979	17444	21199	24658	31138	40341	47523

ООО «ТИ-СИСТЕМС» ИНЖИНИРИНГ И ПОСТАВКА ТЕХНОЛОГИЧЕСКОГО ОБОРУДОВАНИЯ

Интернет: www.tisys.ru www.tisys.kz www.tisys.by www.tesec.ru www.ти-системс.рф

Телефоны: +7 (495) 7774788, 7489626, (925) 5007155, 54, 65 Эл. почта: info@tisys.ru info@tisys.kz info@tisys.by

Quadax[®] butterfly valve

LUG TYPE VERSION

PRODUCT FEATURES

On the lug type version with threaded flange holes, the valve is screwed directly onto the pipe flanges on both sides. It has the shortest length and therefore can save a lot of space and reduce operating costs.

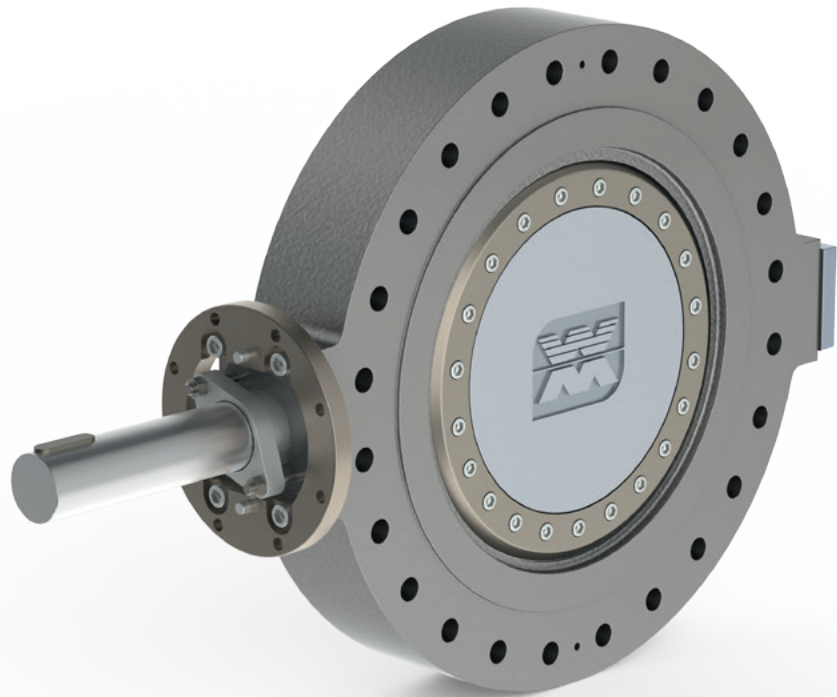

SPECIFICATIONS

Nominal size	DN 50–1800, 2”-70” and above
Length	EN 558 R16 (PN10–PN63) API 609 short class 150–600
Materials	Steel, stainless steel, special materials (duplex, inconel, bronze)
Function	NC, NO, DA
Pressure range	Body pressure up to 63 bar Δp standard shaft 52 bar in both directions
Leak rate	1 DIN 3230, A DIN EN 12266, BS 6364, Fire safe, API 598, ANSI FCI 70-2 Class VI
Flow direction	bi-directional with preferred direction indicated on the valve
Operating and ambient temperature	Standard –10°C to +450°C With special materials –270°C to +800°C
Approvals	PED, Fire safe, BAM, TA Luft, ATEX, SIL 3 etc.

TECHNICAL DATA

Nominal size	80	100	125	150	200	250	300	350	400	450	500	600	700	750	800	900	1000
Kv value Δp max. 20 bar							3837	5478	7944	10735	12921	20651	25473	32661	36123	47565	56131
Cv value Δp max. 52 bar	118	258	418	654	1445	2451	3720	5120	7321	9986	12118	19253	23081	30015	33343	43215	51398
Kv value Δp max. 290 psi							4462	6370	9237	12483	15024	24013	29620	37978	42003	55308	65269
Cv value Δp max. 754 psi	137	300	486	760	1680	2850	4314	5953	8513	11612	14091	22387	26838	31702	38771	50250	59765

Quadax® butterfly valve BUTTWELD VERSION

Quadax® butterfly valve BUTTWELD VERSION TOP ENTRY

Pipeline construction (LNG)

Maintenance and repair
work in installed position

Reduced risk of
unnoticed leakages

PRODUCT FEATURES

The buttweld version is primarily used in free sections of pipelines. This version with no flange connections significantly reduces the risk of unnoticed leakages.



SPECIFICATIONS

Nominal size	DN 50-1000, 2"-40" and above
Length	EN558 R14 / ISO 5752 F4 (PN10-160/class 150-900)
Materials	Steel, stainless steel, special materials (duplex, inconel)
Function	NC, NO, DA
Pressure range	Body pressure up to 160 bar Δp standard shaft 52 bar in both directions Δp special shaft 100 bar in both directions
Leak rate	1 DIN 3230, A DIN EN 12266, BS 6364, Fire safe, API 598, ANSI FCI 70-2 Class VI
Flow direction	bi-directional with preferred direction indicated on the valve
Operating and ambient temperature	Standard -10°C to +450°C With special materials -270°C to +800°C
Approvals	PED, Fire safe, BAM, TA Luft, ATEX, SIL 3 etc.

TECHNICAL DATA

Nominal size	80	100	125	150	200	250	300	350	400	450	500	600	700	750	800	900	1000
Δp max. 20 bar							3837	5478	7944	10735	12921	20651	25473	32661	36123	47565	56131
Kv value Δp max. 52 bar	118	258	418	654	1445	2451	3720	5120	7321	9986	12118	19253	23081	30015	33343	43215	51398
Δp max. 104 bar					1254	2123	3180	4459	6282	8738	10245	16458	19826	22286	28632	38954	44444
Δp max. 155 bar	101	208	344	576	1164	1916	2926	3962	5659	7989	9442	15002	18231	21206	26779	34693	40870
Δp max. 290 psi							4462	6370	9237	12483	15024	24013	29620	37978	42003	55308	65269
Cv value Δp max. 754 psi	137	300	486	760	1680	2850	4314	5953	8513	11612	14091	22387	26838	31702	38771	50250	59765
Δp max. 1500 psi					1458	2469	3698	5185	7305	10160	11913	19137	23053	25914	33293	45295	51679
Δp max. 2250 psi	117	242	400	670	1353	2228	3402	4607	6580	9290	10979	17444	21199	24658	31138	40341	47523

ООО «ТИ-СИСТЕМС» ИНЖИНИРИНГ И ПОСТАВКА ТЕХНОЛОГИЧЕСКОГО ОБОРУДОВАНИЯ

Интернет: www.tisys.ru www.tisys.kz www.tisys.by www.tesec.ru www.ти-системс.рф

Телефоны: +7 (495) 7774788, 7489626, (925) 5007155, 54, 65 Эл. почта: info@tisys.ru info@tisys.kz info@tisys.by

Quadax® butterfly valve

GATE VALVE REPLACEMENT

PRODUCT FEATURES

The design of the gate valve replacement has been developed to allow a ball valve or a gate valve to be replaced without modification of the piping system. Unlike other valve design principles, by using Quadax® you will save space and weight, and also reduce the operating costs.

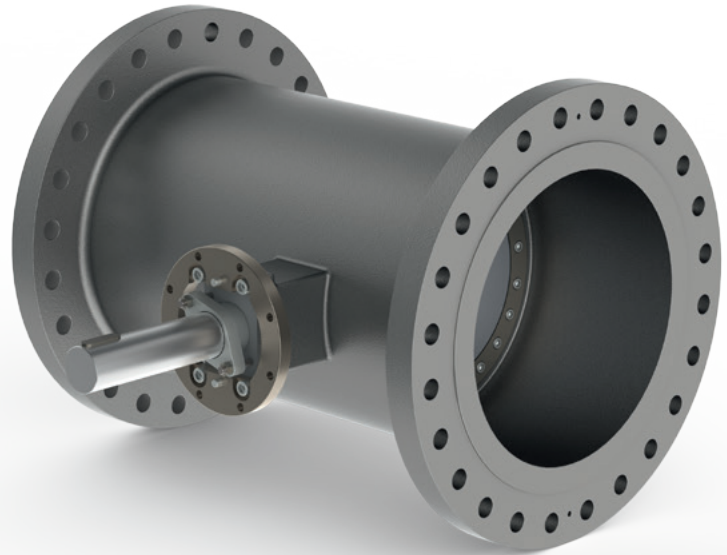

SPECIFICATIONS

Nominal size	DN 80-1000, 3"-40" and above
Length	ANSI B16.10 long Pattern (PN 10-160/class 150-900)
Materials	Steel, stainless steel, special materials (duplex, inconel, bronze)
Function	NC, NO, DA
Pressure range	Body pressure up to 100 bar
	Δp standard shaft 52 bar in both directions Δp special shaft 100 bar in both directions
Leak rate	1 DIN 3230, A DIN EN 12266, BS 6364, Fire safe, API 598, ANSI FCI 70-2 Class VI
Flow direction	bi-directional with preferred direction indicated on the valve
Operating and ambient temperature	Standard -10°C to +450°C
	With special materials -270°C to +800°C
Approvals	PED, Fire safe, BAM, TA Luft, ATEX, SIL 3 etc.

TECHNICAL DATA

Nominal size	80	100	125	150	200	250	300	350	400	450	500	600	700	750	800	900	1000
Δp max. 20 bar							3837	5478	7944	10735	12921	20651	25473	32661	36123	47565	56131
Kv value Δp max. 52 bar	118	258	418	654	1445	2451	3720	5120	7321	9986	12118	19253	23081	30015	33343	43215	51398
Δp max. 104 bar					1254	2123	3180	4459	6282	8738	10245	16458	19826	22286	28632	38954	44444
Δp max. 155 bar	101	208	344	576	1164	1916	2926	3962	5659	7989	9442	15002	18231	21206	26779	34693	40870
Δp max. 290 psi							4462	6370	9237	12483	15024	24013	29620	37978	42003	55308	65269
Cv value Δp max. 754 psi	137	300	486	760	1680	2850	4314	5953	8513	11612	14091	22387	26838	31702	38771	50250	59765
Δp max. 1500 psi					1458	2469	3698	5185	7305	10160	11913	19137	23053	25914	33293	45295	51679
Δp max. 2250 psi	117	242	400	670	1353	2228	3402	4607	6580	9290	10979	17444	21199	24658	31138	40341	47523

ООО «ТИ-СИСТЕМС» ИНЖИНИРИНГ И ПОСТАВКА ТЕХНОЛОГИЧЕСКОГО ОБОРУДОВАНИЯ

Интернет: www.tisys.ru www.tisys.kz www.tisys.by www.tesec.ru www.ти-системс.рф

Телефоны: +7 (495) 7774788, 7489626, (925) 5007155, 54, 65 Эл. почта: info@tisys.ru info@tisys.kz info@tisys.by

KV/CV CHARACTERISTIC CURVE

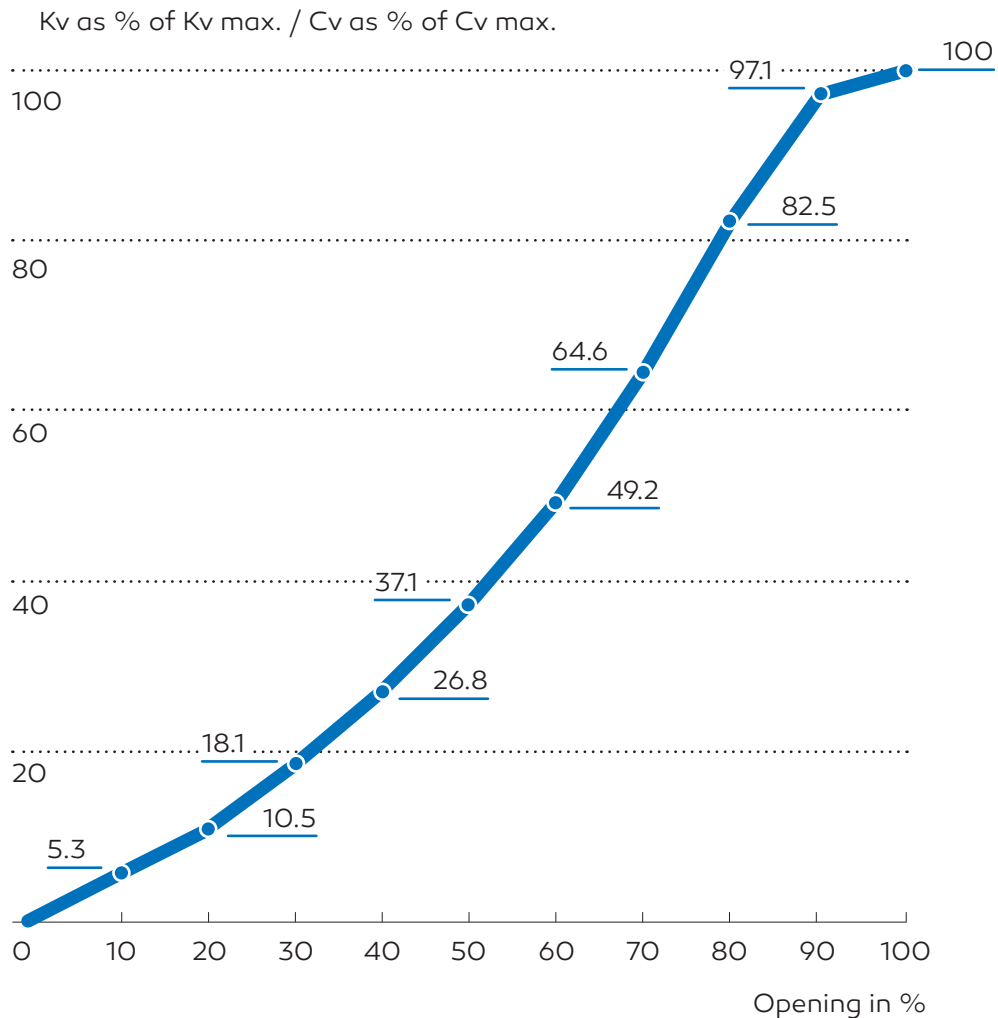

TECHNICAL DATA

Nominal size	80	100	125	150	200	250	300	350	400	450	500	600	700	750	800	900	1000
Kv value																	
Δp max. 20 bar	3837 5478 7944 10735 12921 20651 25473 32661 36123 47565 56131																
Δp max. 52 bar	118	258	418	654	1445	2451	3720	5120	7321	9986	12118	19253	23081	30015	33343	43215	51398
Δp max. 104 bar	1254 2123 3180 4459 6282 8738 10245 16458 19826 22286 28632 38954 44444																
Δp max. 155 bar	101	208	344	576	1164	1916	2926	3962	5659	7989	9442	15002	18231	21206	26779	34693	40870
Δp max. 290 psi	4462 6370 9237 12483 15024 24013 29620 37978 42003 55308 65269																
Cv value																	
Δp max. 754 psi	137	300	486	760	1680	2850	4314	5953	8513	11612	14091	22387	26838	31702	38771	50250	59765
Δp max. 1500 psi	1458 2469 3698 5185 7305 10160 11913 19137 23053 25914 33293 45295 51679																
Δp max. 2250 psi	117	242	400	670	1353	2228	3402	4607	6580	9290	10979	17444	21199	24658	31138	40341	47523

All technical details are correct at the time of going to print. We reserve the right to make technical modifications. Unfortunately, we cannot completely rule out errors. We ask for your understanding that the information, figures and descriptions in this document cannot be used as the basis for any legal claims. The texts, photographs, technical drawings and all other forms of representation contained in this publication are copyrighted by müller quadax gmbh. Any further use requires the explicit consent of müller quadax gmbh.

ООО «ТИ-СИСТЕМС» ИНЖИНИРИНГ И ПОСТАВКА ТЕХНОЛОГИЧЕСКОГО ОБОРУДОВАНИЯ

Интернет: www.tisys.ru www.tisys.kz www.tisys.by www.tesec.ru www.ти-системс.рф

Телефоны: +7 (495) 7774788, 7489626, (925) 5007155, 54, 65 Эл. почта: info@tisys.ru info@tisys.kz info@tisys.by

SUCCESS STORY – BUBBLE TIGHT IN CRYOGENIC APPLICATIONS



THE APPLICATION

The increased storage and reprocessing of LNG (liquefied natural gas) has led to a sharp rise in demand for systems for the cryogenic sector in recent years. To enable the gas to be transported economically, it is cooled down to -165°C and thus liquefied. These systems frequently require shut-off valves that have to achieve a high level of tightness in this application (-162°C LNG to -196°C nitrogen/oxygen). Many manufacturers of triple offset butterfly valves have problems complying with the required leak rate set out in BS 6364. This issue is due to the geometry of the sealing area on the triple offset butterfly valves.

SOLUTION/COMPETITIVE ADVANTAGE

In contrast to the elliptical seal geometry of conventional triple offset valves, Quadax[®] features a completely circular seal geometry. This means that the wall and material thickness is the same all the way around. This design enables bubble tight to be guaranteed even with extreme temperature fluctuations or in cryogenic applications (down to -196°C). Triple offset valves, on the other hand, have different wall and material thicknesses because of the elliptical seal geometry. In cryogenic applications or with extreme temperature differences, this leads to different shrinkage and expansion of the material at the seat, which can result in leaks.

PRACTICAL EXAMPLE – LINDE AG

One of the müller quadax gmbh's key customers for applications in the cryogenic sector is Linde AG, who were very interested in finding a tight shut-off valve for their air fractionation systems.

AIR FRACTIONATION SYSTEMS

The air fractionation system project involves the following applications:

"In cryogenic air fractionation systems, low temperature rectification can be used to produce oxygen, nitrogen and argon. Cryogenic air fractionation can also be used to obtain other noble gases such as krypton, xenon, helium and neon. The systems can create products in a gaseous state for pipelines or cryogenically liquefied for storage and transportation by truck. (...)"*

"CRYO TEST"

With the four offset butterfly valve, müller quadax gmbh was not only able to comply with the leak rate stipulated in the well-known BS 6364 standard, they actually managed to exceed it. Example using nominal size DN300:
BS 6343 allows:
 $100 \text{ mm}^3/\text{s} \times 300 = 30,000 \text{ mm}^3/\text{s} = 1,800 \text{ ml}/\text{min}$
Quadax[®] achieves no visible leakages

* Source: www.linde-engineering.com/de/process_plants/air_separation_plants/

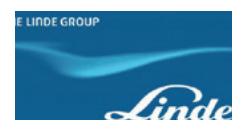



MÜLLER QUADAX GMBH – A COMPANY OF THE MÜLLER-CO-AX GROUP

Over 50 years of müller co-ax. A company having grown from the humblest of beginnings into the epitome of valve technology within the industry.

We are synonymous for innovation and individuality, for confidence and quality, for experience and reliability in valve technology. This has been the case since the beginning of our dynamic development and it will continue to stay that way.

More than 50 years of experience also brings responsibility with it, however: to our company, to what we have achieved with our employees and of course to our costumers.

THINK GLOBAL, ACT LOCAL

Our headquarters are located in Forchtenberg (Baden-Württemberg). But our products are used all over the world – wherever high pressures and extreme temperatures mean that uncompromising quality and stringent requirements go hand in hand.

FAMILY COMPANY

For our customers we combine the values and flexibility of a family-owned company with a long-term perspective and the professionalism of a global player. These are only three of the reasons to work with us.

We look forward to hearing from you!

müller quadax gmbh
Teslastrasse 6
74670 Forchtenberg
Germany

ООО «ТИ-СИСТЕМС» ИНЖИНИРИНГ И ПОСТАВКА ТЕХНОЛОГИЧЕСКОГО ОБОРУДОВАНИЯ

Интернет: www.tisys.ru www.tisys.kz www.tisys.by www.tesec.ru www.ти-системс.рф

Телефоны: +7 (495) 7774788, 7489626, (925) 5007155, 54, 65 Эл. почта: info@tisys.ru info@tisys.kz info@tisys.by